

Hot Runner and Controllers

Product Handbook

Version 18.1

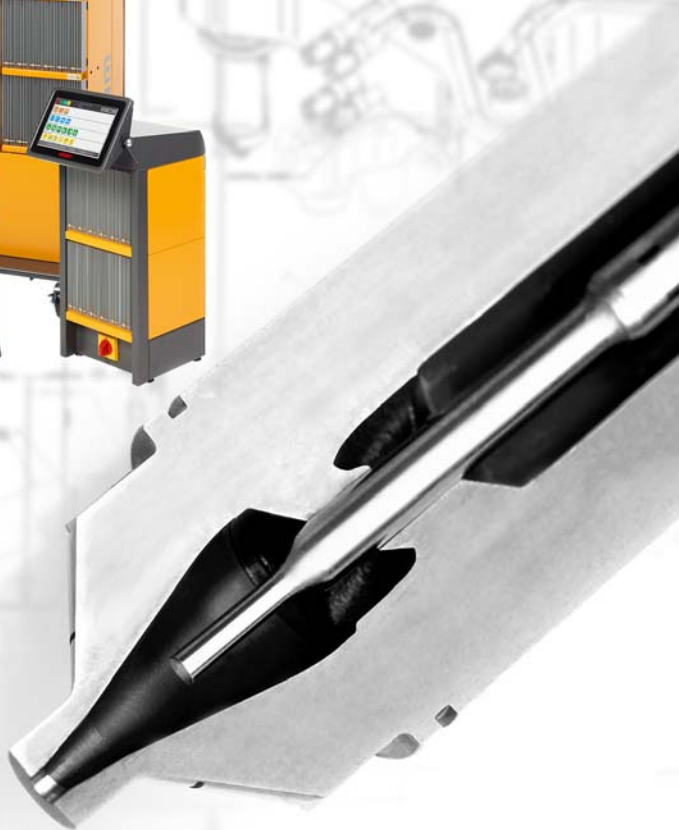

HUSKY

Keeping our customers in the lead

Table of Contents

- Section 1 General Hot Runner Information**
- Section 2 Valve Gate Nozzle Stacks**
- Section 3 UltraSync**
- Section 4 Individual Servo Valve Gate (ISVG)**
- Section 5 Hot Tip Nozzle Stacks**
- Section 6 Ultra SideGate**
- Section 7 PRONTO**
- Section 8 Stack Hot Runners**
- Section 9 UNIFY**
- Section 10 Bolted Manifold System**
- Section 11 Services**
- Section 12 General Controller Information**
- Section 13 Operator Interface**
- Section 14 H-Series Card**
- Section 15 Cables**
- Section 16 Altanium Servo Control**
- Section 17 Valve Gate Sequencer**

In this section:

Page

1-1 Ultra Advantage

1-2 Hot Runner System

1-3 Nozzle Sizes

1-4 Melt Flow Index / Viscosity

Ultra Advantage

UltraGuide

- Reduced gate and stem wear
- Stem pre-aligned before gate
- Cylindrical shut-off



UltraSeal

- Guaranteed leakproof operation
- Less plate deflection
- Preload nozzle to manifold



Ease of Maintenance

- Nozzle tips, thermocouples and heaters are replaceable in the press
- Single O-ring operates in a cooled backing plate for reduced maintenance



Ultra Helix

- Superior gate quality with precise stem alignment
- Industry leading gate longevity
- Continuous valve stem guidance

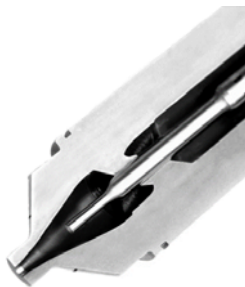

Wear Resistant Tips

- Improved longevity when processing abrasive materials



Wide Operating Window

- Wide temperature ranges without stringing or freeze-off
- Faster cycle times
- Robust seal-off





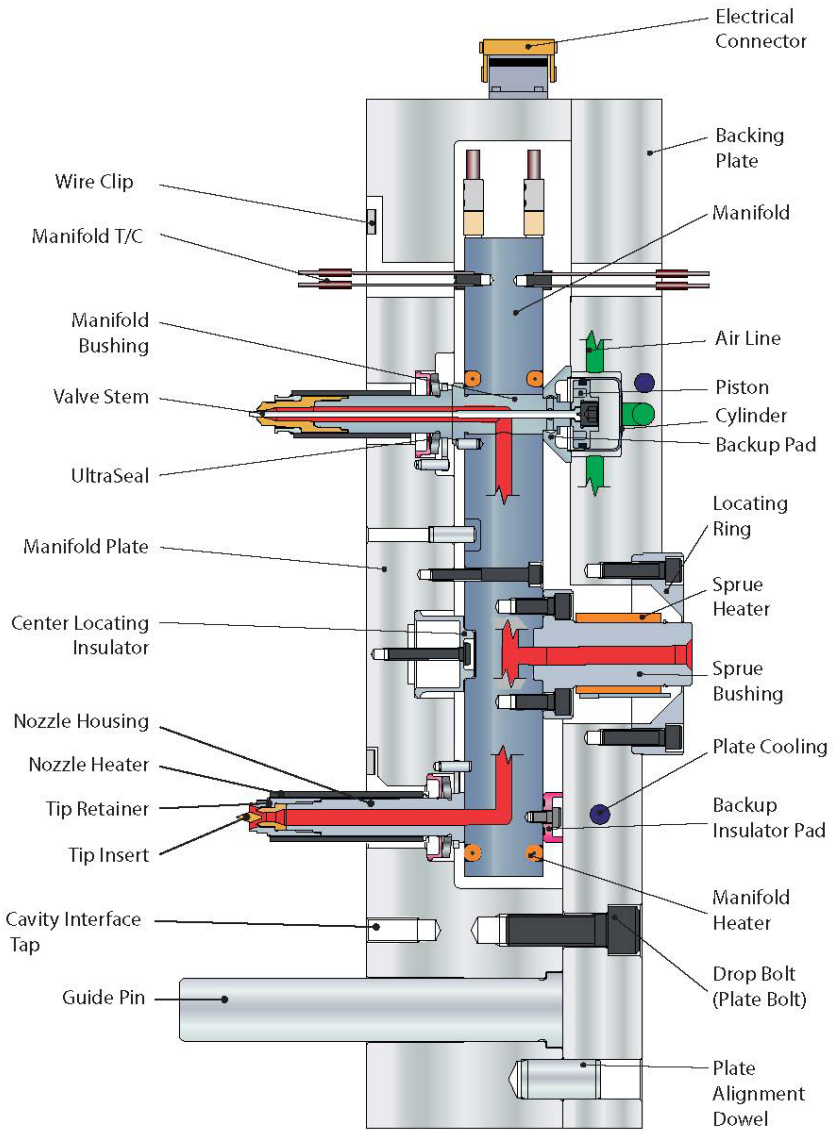

Hot Runner System

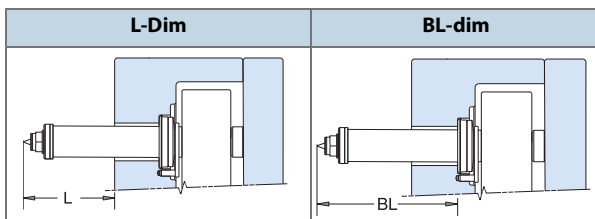

Nozzle Sizes



Nozzle Size	L-Dim Range		BL-Dim Range	
	Hot Tip	Valve Gate	Hot Tip	Valve Gate
 Ultra 1000	28 – 300mm [1.10 – 11.81"]	29.3 – 300mm [1.15 – 11.81"]	82 – 320mm [3.22 – 12.59"]	82 – 320mm [3.22 – 12.59"]
 Ultra 750 & Ultra Helix 750 (VG only)	27.4 – 290mm [1.08 – 11.41"]	27.4 – 290mm [1.08 – 11.41"]	57 – 305mm [2.24 – 12"]	64 – 305mm [2.51 – 12"]
 Ultra 500 & Ultra Helix 500 (VG only)	14 – 290mm [0.55 – 11.41"]	20 – 290mm [0.79 – 11.41"]	70 – 305mm [2.75 – 12"]	85 – 305mm [3.34 – 12"]
 Ultra 350 & Ultra Helix 350 (VG only)	17 – 170mm [0.67 – 6.69"]	17 – 170mm [0.67 – 6.69"]	53 – 185mm [2.08 – 7.28"]	53 – 185mm [2.08 – 7.28"]
 Ultra 250 & Ultra Helix 250 (VG Only)	13 – 150mm [0.51 – 5.90"]	13 – 150mm [0.51 – 5.90"]	79 – 165mm [2.75 – 6.49"]	79 – 165mm [2.75 – 6.49"]

Notes:

- For L-Dimensions above or below range, contact Husky

Melt Flow Index / Viscosity

Resin	Low Viscosity	Medium Viscosity	High Viscosity
ABS		14	1
CAP	*		
HDPE	68		1
LDPE	23	2	
PC			25 5
PEI			18 2
PETG		*	
PMMA		24	1
PPA			*
PPO		18	3
PS	40	2	
PSU			20 5
PUR	*		
TPE	*		
PVC		20	3
SAN		27	4
TPO		41	2
LCP		*	
PA	*		
PBT		*	
PET		*	
POM		23	1
PP	53	2	
PPS			*
PBT/PC		15	5
PC/ABS		25	2

Bars represent typical Melt Flow Index ranges

* Resins with no numbers shown are not typically characterized with MFI values.

In this section:

Page

2-1	Key Advantages
2-2	Gate Quality Guidelines
2-3	Valve Stem Actuation Options
2-4	Valve Stem Actuation Option
2-5	Product Matrix
2-8	Ultra Helix Gate Detail Dimensions
2-12.....	Pitch Spacing
2-15.....	Ultra Helix Valve Gate Technology
2-17.....	Ultra Helix 250 T2 Nozzle Stack
2-18.....	Ultra Helix Packaging VG
2-19.....	Ultra Helix 250 Valve Gate-Application Guidelines
2-20.....	Ultra Helix 350 Valve Gate-Application Guidelines
2-21.....	Ultra Helix 500 Valve Gate-Application Guidelines
2-22.....	Ultra Helix 750 Valve Gate-Application Guidelines
2-23.....	Ultra 350 Valve Gate-Application Guidelines
2-24.....	Ultra 500 Valve Gate-Application Guidelines
2-25.....	Ultra 750 Valve Gate-Application Guidelines
2-26.....	Ultra 1000 Valve Gate-Application Guidelines

In this section:

Page

2-27..... Single Drops

2-28.....Single Drops-SCVG

2-29.....Ultra 500 HP - High Pressure (VG/VX)

2-30.....Valve Gate Air Circuit Recommendations and Machine Setup

Key Advantages

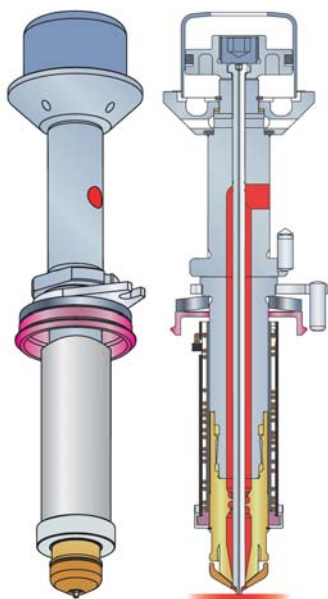

Ease of Maintenance

- O-ring replaceable without pulling valve stems
- Double Delta O-ring in cooled backing plate doubles seal life
- Tips, nozzle heaters & T/Cs replaceable in the press

UltraSeal

- 3 year guaranteed leakproof operation
- Pre-loads nozzle to manifold
- Minimizes plate deflection / bowing

UltraGuide/Ultra Helix

- Valve stem pre-aligned before gate
- Reduced gate / stem wear
- Thermally conductive component for fast start-up
- Cylindrical (Plunger) shut-off for improved gate quality



Valve Gate Stem Shut-off Options

Cylindrical (Plunger)		<ul style="list-style-type: none"> • 0° shut-off • Ultra Helix technology pre-aligns stem to gate, minimizing gate wear • Superior gate quality for non-abrasive resins • Requires higher manufacturing tolerances
Taper		<ul style="list-style-type: none"> • 40° shut-off • Gate geometry used to align valve stem • Requires more strength in gate area to avoid premature cracking

Plunger vs. Taper General Stem Shut-Off Guideline

Description	Plunger <i>(Whenever possible Husky will use a plunger stem shut-off)</i>	Taper
Gate Quality Expectations	Best	Good
Gate Quality vs. Cycle Time	Gate	Cycle
Mfg. Tolerance Requirements	High	Medium
Wall Thickness in Gate Area	Thick	Thin
Crack Development in Gate Area	Unlikely	Potential

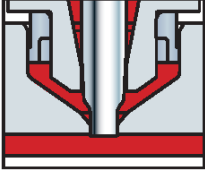
Gate Quality Guidelines

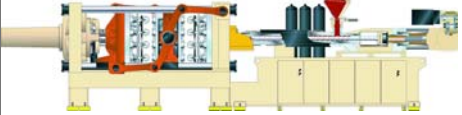
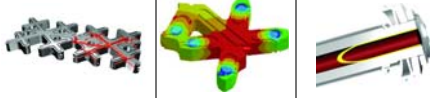
Factors Influencing Gate Quality					
Tip / Gate Variables	Gate detail tolerances		Shut-off Style		
	Gate wear				
	Gate cooling				
	Shut-off style			Taper	Plunger
	Stem position / length				
	Gate diameter / land				
Manifold Variables	Flow balance				
	Thermal balance				
	Melt channel sizing				
Processing Variables	Stem open/close timing				
	Pneumatic pressure				
	Injection speed				
	Melt temperature				
	Mold temperature				
	Cooling time				
	Decompression				
	Hold time				

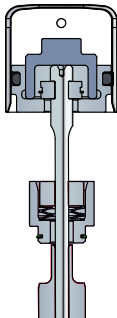
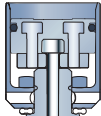
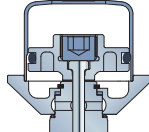
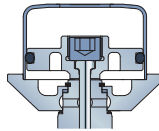
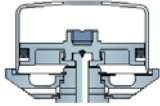

Valve Stem Actuation Options

Actuation	Key points	Nozzle Sizes Available	
PX (Tight Access)	<ul style="list-style-type: none"> • Double Delta O-ring design for ease of maintenance • Small diameter piston for tight pitch spacing down to 25.4mm (1") • Extended maintenance interval design to combat weepage prone resins 	Ultra Helix 250	
SX (Small Pitch)	<ul style="list-style-type: none"> • Double Delta O-ring design for ease of maintenance • Up to 200psi (13.8bar) air pressure may be required for proper operation of SX valve gated systems • Insufficient air pressure provided to SX piston can lead to stems seizing, sticking, and/or posting on the molded part 	Ultra 350 Ultra 500 Ultra Helix 350 Ultra Helix 500	
LX (Standard)	<ul style="list-style-type: none"> • Double Delta O-ring design for ease of maintenance 	Ultra 350 Ultra 500 Ultra 750 Ultra Helix 350 Ultra Helix 500 Ultra Helix 750	
EX (Large Piston)	<ul style="list-style-type: none"> • Double Delta O-ring design for ease of maintenance • Used for high stem force applications 	Ultra 350 Ultra 500 Ultra 750 Ultra Helix 350 Ultra Helix 500 Ultra Helix 750	
Ultra 1000	<ul style="list-style-type: none"> • Double Delta O-ring design for ease of maintenance • Used for medium sized parts 	Ultra 1000	

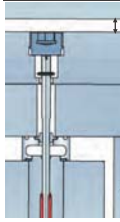
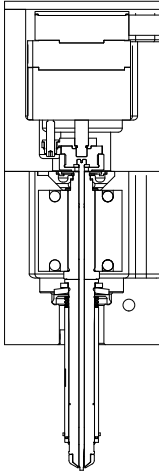
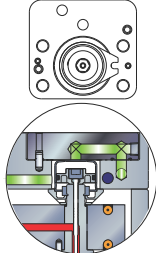
Valve Stem Actuation Option (continued)



Actuation	Key points	Nozzle Sizes Available	
<p>UltraSync Plate Actuation</p>	<ul style="list-style-type: none"> • All standard valve gating styles • Actuation drive designs <ul style="list-style-type: none"> ○ Electric (Servo Motor) - UltraSync-E ○ Hydraulic - UltraSync-H ○ Pneumatic - UltraSync-P <p><i>* UltraSync-H not available with Ultra Helix 250</i></p>	<p>Ultra 350 Ultra 500 Ultra 750 Ultra Helix 250* Ultra Helix 350 Ultra Helix 500 Ultra Helix 750</p>	
<p>Individual Servo Valve Gate (ISVG)</p>	<ul style="list-style-type: none"> • Gating styles available - VG, VX, Ultra Helix • Plunger only 	<p>Ultra 350, 500, 750 Ultra Helix 350, 500, 750</p>	
<p>Air Plate</p>	<ul style="list-style-type: none"> • Allows for easy access to back end valve components • O-rings, cylinder caps, pistons and stems accessible in the press without removing backing plate • Limiting factor for tight pitch applications • Individual drop airplate or multi-drop airplates are available 	<p>All</p>	

Product Matrix - Helix

Gating Style	Application Overview	Ultra Helix 250		Ultra Helix 350		Ultra Helix 500		Ultra Helix 750	
		T	P	T	P	T	P	T	P
Ultra Helix T1/ T2 	Excellent gate quality with precise stem alignment.	X	✓	X	✓	X	✓	X	✓
Ultra Helix VG 	Excellent gate quality with gate hole included in tip	X	X	X	✓	X	✓	X	✓

✓	X	T	P
Standard Product	Not Available	Taper	Plunger

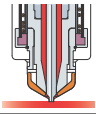
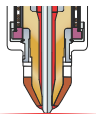
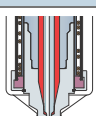
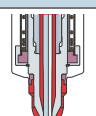
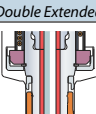
Product Matrix - Other

Gating Style	Application Overview	Ultra 350		Ultra 500		Ultra 750		Ultra 1000	
		T	P	T	P	T	P	T	P
VG 	General purpose valve gate. Suitable for most resins	✓	✓	✓	✓	✓	✓	✓	✓
VG-R (Retrofit) 	General purpose valve gate for retrofitting into 750 Series VG gate details	X	X	X	X	✓	✓	X	X
VX 	General purpose valve gate with gate shutoff within the nozzle tip. Typically applied on abrasive applications. Offers simplified gate detail	✓	✓	✓	✓	✓	✓	✓	X
VG-X (Extended) 	Extended valve gate for improved gate access	X	X	✓	✓	X	X	X	X
VG-XX (Double Extended) 	Double extended valve gate for improved gate access	X	X	✓	✓	X	X	X	X
VG-HP (High Pressure) 	Single piece valve gate nozzle tip and housing for high pressure applications. (Only for Ultra 500) Typically used for Telecom	X	X	✓	✓	X	X	X	X
✓	X	T		P					
Standard Product	Not Available	Taper		Plunger					

Product Matrix - Other

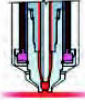
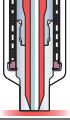
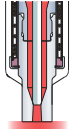
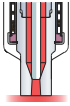
Gating Style	Application Overview	Ultra 350		Ultra 500		Ultra 750		Ultra 1000	
		T	P	T	P	T	P	T	P
VX-HP <i>(High Pressure)</i> 	Valve gate with gate shutoff within the nozzle tip. For high pressure applications. Typically used for Telecom. Offers simplified gate detail	X	X	X	✓	X	X	X	X
VX-X <i>(Extended)</i> 	Extended VX for increased gate access and/or customization of the contact land. Typically applied on Automotive applications. Offers simplified gate detail	X	X	X	X	X	X	✓	X
VX-X XS <i>(Extended Extra Stock)</i> 	Extended VX with extra stock for increased gate access and tip contouring. Typically applied on Automotive applications	X	X	X	X	X	X	✓	X
VX-XS <i>(Extra Stock)</i> 	Extended VX with extra stock tip for contouring	X	X	✓	X	✓	✓	✓	X

✓	X	T	P
Standard Product	Not Available	Taper	Plunger

Ultra Helix Gate Detail Dimensions

Gate Detail Dimensions (mm [in])									
Size	Tip Style	A*	B	C	D	E	F	Gate Detail	Std. Gate Dia
Ultra Helix 250	T2	12.0 [0.47"]	7.0 [0.28"]	7.6 [0.3"]	3.4 [0.14"]	—	—		0.8 [0.032"] 1.0 [0.039"] 1.2 [0.047"]
Ultra Helix 350	T1/T2	16.0 [0.63"]	8.00 [0.31"]	8.3 [0.33"]	2.6 [0.10"]	—	—		1.0 [0.039"] 1.2 [0.047"] 1.5 [0.059"]
Ultra Helix 350	VG	16.0 [0.63"]	—	—	4.22 [0.16"]	See next page	1.5 [0.059"]		0.8 [0.031"] 1.0 [0.039"] 1.2 [0.047"] 1.5 [0.059"]
Ultra Helix 500	T1/T2	23.8 [0.94"]	10.01 [0.394"]	7.4 [0.29"]	4.1 [0.162"]	—	—		1.0 [0.039"] 1.2 [0.047"]
Ultra Helix 500	VG	23.8 [0.94"]	—	—	4.68 [0.184"]	See next page	1.50 [0.059"]		1.5 [0.059"] 1.8 [0.070"]
Ultra Helix 500	VG Packaging	23.8 [0.937"]	—	—	—	4.00 [0.157"]	4.1 [0.161"]		1.2 [0.047"] 1.5 [0.059"] 1.8 [0.070"]

Ultra Helix Gate Detail Dimensions

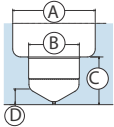
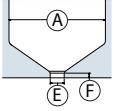
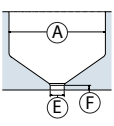
Gate Detail Dimensions (mm [in])									
Size	Tip Style	A*	B	C	D	E	F	Gate Detail	Std. Gate Dia
UltraHelix 750	T1/T2	31.0 [1.22"]	19.06 [0.7504"]	17.3 [0.68"]	5.91 [0.233"]	—	—		1.0 [0.039"] 1.5 [0.059"] 1.8 [0.070"] 2.5 [0.098"]
UltraHelix 750	VG	31.0 [1.22"]	—	—	—	See below	2.00 [0.078"]		1.2 [0.047"] 1.5 [0.059"] 1.8 [0.070"]
Ultra Helix 750	VG Packaging	31.0 [1.22"]	—	—	—	5.00 [0.197"]	4.2 [0.165"]		1.2 [0.047"] 1.5 [0.059"] 1.8 [0.070"]

* Effective interfacing diameter on manifold plates is 35.0 [1.377"]

Ultra Helix VG Tip Diameter	
Gate Dia	E
0.8 (0.031")	3.0 (0.118")
1.0 (0.039")	3.0 (0.118")
1.2 (0.047")	3.2 (0.126")
1.5 (0.059")	3.5 (0.138")
1.8 (0.070")	3.8 (0.150")
2.5 (0.098")	4.5 (0.177")

Valve Gate Detail Dimensions

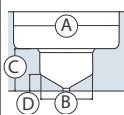
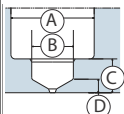
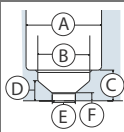
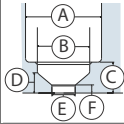
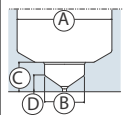
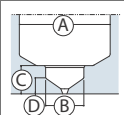
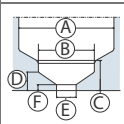
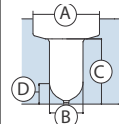
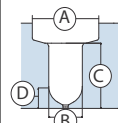
Gate Detail Dimensions (mm [in])									
Size	Tip Style	A	B	C	D	E	F	Gate Detail	Std. Gate Dia
Ultra 350	VG-P	16.0 [0.63"]	8.00 [0.31"]	8.3 [0.33"]	2.6 [0.10"]*	—	—		1.0 [0.039"] 1.2 [0.047"]
Ultra 350	VG-T	16.0 [0.63"]	8.00 [0.31"]	8.3 [0.33"]	3 [0.12"]*	—	—		1.5 [0.059"]
Ultra 350	VX-P	16.0 [0.63"]	11.0 [0.43"]	6.5 [0.26"]	4.22 [0.16"]	4.905 [0.19"]	1.5 [0.059"]		1.5 [0.059"]
Ultra 350	VX-T	16.0 [0.63"]	11.0 [0.43"]	6.5 [0.26"]	4.22 [0.16"]	4.905 [0.19"]	1.5 [0.059"]		1.5 [0.059"]
Ultra 500	VG-P	23.8 [0.94"]	10.01 [0.394"]	7.4 [0.29"]	4.1 [0.162"]	—	—		1.0 [0.039"]
Ultra 500	VG-T	23.8 [0.94"]	10.01 [0.394"]	7.4 [0.29"]	4.1 [0.162"]	—	—		1.2 [0.047"]
Ultra 500	VX	23.8 [0.94"]	14.0 [0.55"]	6.52 [0.257"]	4.68 [0.184"]	4.905 [0.193"]	1.50 [0.059"]		1.5 [0.059"] 1.8 [0.070"]
Ultra 500	VG-X	23.8 [0.94"]	12.01 [0.472"]	17.4 [0.69"]	7.48 [0.294"]	—	—		1.8 [0.070"]
Ultra 500	VG-XX	23.8 [0.94"]	12.01 [0.472"]	22.4 [0.88"]	7.48 [0.294"]	—	—		1.8 [0.070"]

* Flexible measurement to be confirmed with original gate detail drawing
 Additional gate sizes available upon review

Valve Gate Detail Dimensions

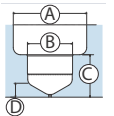
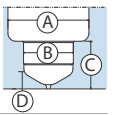
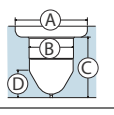
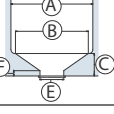
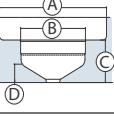
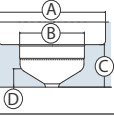
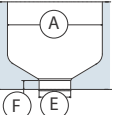
Gate Detail Dimensions (mm [in])										
Size	Tip Style	A*	B	C	D	E	F	G	Gate Detail	Std. Gate Dia
Ultra 750	VG-P VG-UF(P)	31.0 [1.22"]	19.06 [0.7504"]	17.3 [0.68"]	5.91 [0.233"]	—	—	—		1.0 [0.039"] 1.2 [0.047"] 1.5 [0.059"] 1.8 [0.070"] 2.5 [0.098"]
Ultra 750	VG-T VG-UF(T)	31.0 [1.22"]	19.06 [0.7504"]	17.3 [0.68"]	5.91 [0.233"]	—	—	—		
Ultra 750	VG-R (P) VG-R (T)	31.0 [1.22"]	19.06 [0.7504"]	25.0 [0.98"]	11.28 [0.444"]	—	—	—		
Ultra 750	VX	31.0 [1.22"]	24.7 [0.97"]	7.5 [0.30"]	—	9.005 [0.3545"]	2.00 [0.078"]	—		
Ultra 1000	VG (3 mm gate)	42.0 [1.65"]	25.415 [1.000"]	15.61 [0.615"]	7.32 [0.288"]	—	—	—		3.0 [0.118"] 5.0 [0.197"]
Ultra 1000	VG (5 mm gate)	42.0 [1.65"]	25.415 [1.000"]	15.61 [0.615"]	6.75 [0.266"]	—	—	—		
Ultra 1000	VX	42.0 [1.65"]	—	—	—	14.00 [0.551"]	3.95 [0.156"]	—		

* Effective interfacing diameter on manifold plates is 35.0 [1.377"]

Pitch Spacing

Nozzle Size	Valve Stem Actuation Options	Guidelines	Min Pitch Layout
Ultra Helix 250	Tight Access Valve Gate (PX)	<p>The sprue min radius is 45mm [1.77"]</p> <p>The min drop-to-drop pitch is 25.4mm [1.00"]</p> <p>X and Y must be greater than 62.6mm [2.47"]</p> <p>Extended maintenance interval design to combat weepage prone resins</p>	
Ultra 250	Small Pitch Valve Gate (SX)	<p>The sprue min radius is 45mm [1.77"]</p>	
Ultra 350		<p>The min drop-to-drop pitch is 25.4mm [1.00"]</p> <p>X and Y must be greater than 62.6mm [2.47"]</p>	
Ultra 500		<p>200psi (13.8bar) air pressure may be required for proper operation. Insufficient air pressure can lead to stem actuation problems, sticking, and or posting on the molded part</p>	
Ultra Helix 350		<p>Certain applications will require air pressure greater than standard air pressure of 80-120psi [5.5-8.3bar]</p>	
Ultra Helix 500		<p>** Minimum channel size required for minimum pitch</p>	

* Plunger style sprue bushing requires additional spacing. Review required

- Pitch shown is minimum and is based on minimum melt channel sizing. Specific part, resin, and filling requirements could dictate a larger pitch spacing requirement than shown
- Minimum distance between the outermost nozzle drop center to the outer side edge of the manifold plate is 75mm [2.95"]. (If reduced distance is required, contact Husky)
 - For non-PRONTO systems Application Engineering review recommended for distance less than 100mm [3.93"]
- Minimum distance between the outermost nozzle drop center to the outer top and bottom edge of the manifold plate is 100mm [3.93"]. (If reduced distance is required, contact Husky.)
- Nozzles can be grouped in maximum clusters of 8 (except for Ultra 1000)
- Systems greater than 16-drops layouts at minimum pitch spacing need to be reviewed by an Application Engineering
- Tighter pitch layouts may be available, contact Husky
- For UNIFY pitch spacing see UNIFY section

Pitch Spacing (continued)

Nozzle Size	Valve Stem Actuation Options	Guidelines	Min Pitch Layout
Ultra 350	Standard Valve Gate (LX)	<p>The sprue min radius is 50mm [1.97"]</p> <p>The min drop-to-drop pitch is 50mm [1.97"]</p> <p><i>If less than 2.5" (63.5 mm) contact Husky for review.</i></p>	
Ultra 500			
Ultra 750			
Ultra Helix 350			
Ultra Helix 500			
Ultra Helix 750			
Ultra 350	Large Piston Valve Gate (EX)	<p>The sprue min radius is 65mm [2.559"]</p> <p>The min drop-to-drop pitch is 59mm [2.32"]</p> <p>Taper valve stems are not recommended</p>	
Ultra 500			
Ultra 750			
Ultra Helix 350			
Ultra Helix 500			
Ultra Helix 750			

* Plunger style sprue bushing requires additional spacing. Review required

- **Pitch shown is minimum and is based on minimum melt channel sizing. Specific part, resin, and filling requirements could dictate a larger pitch spacing requirement than shown**
- Minimum distance between the outermost nozzle drop center to the outer side edge of the manifold plate is 71mm [2.79"]. (If reduced distance is required, contact Husky)
 - **For non-PRONTO systems** Application Engineering review recommended for distance less than 100mm [3.93"]
- Minimum distance between the outermost nozzle drop center to the outer top and bottom edge of the manifold plate is 96mm [3.77"]. (If reduced distance is required, contact Husky.)
 - **For non-PRONTO systems** Application Engineering review recommended for distance less than 100mm [3.93"]
- Nozzles can be grouped in maximum clusters of 8 (except for Ultra 1000)
- Systems greater than 16-drops layouts at minimum pitch spacing need to be reviewed by an Application Engineering
- Tighter pitch layouts may be available, contact Husky
- **For UNIFY pitch spacing see UNIFY section**

Pitch Spacing (continued)

Nozzle Size	Valve Stem Actuation Options	Guidelines	Min Pitch Layout
Ultra 1000	Valve Gate (No Airplate)	<p>The sprue min radius is 72mm [2.83"]</p> <p>The min drop-to-drop pitch is 75mm [2.95"]</p>	<p>The diagram shows a top-down view of a nozzle stack with eight nozzles arranged in two rows of four. A horizontal dimension line above the top row indicates a pitch of 75mm [2.95"]. A curved dimension line on the right side indicates a sprue radius of R 72mm [2.83"].</p>
Ultra 1000	Valve Gate (Airplate)	<p>The sprue min radius is 115mm [4.53"]</p> <p>The min drop-to-drop pitch is 121mm [4.76"]</p>	<p>The diagram shows a top-down view of a nozzle stack with eight nozzles arranged in two rows of four. A horizontal dimension line above the top row indicates a pitch of 121mm [4.76"]. A curved dimension line on the right side indicates a sprue radius of R 115mm [4.53"].</p>

* Plunger style sprue bushing requires additional spacing. Review required

- **Pitch shown is minimum and is based on minimum melt channel sizing. Specific part, resin, and filling requirements could dictate a larger pitch spacing requirement than shown**
- Minimum distance between the outermost nozzle drop center to the outer side edge of the manifold plate is 71mm [2.79"] (If reduced distance is required, contact Husky)
 - **For non-PRONTO systems** Application Engineering review recommended for distance less than 100mm [3.93"]
- Minimum distance between the outermost nozzle drop center to the outer top and bottom edge of the manifold plate is 96mm [3.77"] (If reduced distance is required, contact Husky.)
 - **For non-PRONTO systems** Application Engineering review recommended for distance less than 100mm [3.93"]
- Nozzles can be grouped in maximum clusters of 8 (except for Ultra 1000)
- Systems greater than 16-drops layouts at minimum pitch spacing need to be reviewed by an Application Engineering
- Tighter pitch layouts may be available, contact Husky
- **For UNIFY pitch spacing see UNIFY section**
- Extended Maintenance Interval (EMI) requires 78mm [3.07"] radial pitch around the sprue bushing to accommodate air plates

Ultra Helix Valve Gate Technology

Ultra Helix Valve Gate Technology

Ultra Helix Valve Gates use advanced technology to provide industry leading gate quality and longevity. Ultra Helix Valve gates provide excellent gate vestige for millions of cycles more than other valve gates.

Every Ultra Helix valve gate tip includes the Ultra Helix valve stem alignment technology. Ultra Helix, developed by Husky, aligns the valve stem to the gate throughout the entire molding cycle reducing wear and extending gate life.

The Ultra Helix VG tip also includes a precision gate integrated in the tip. The gate hole is precisely aligned to the valve stem.

Ultra Helix VG	
Feature	Benefit
All critical gate geometry contained within tip	Superior gate quality with no Complicated gate orifice finishing required
Stem guide integral with gate	Eliminates multiple tolerance stack ups
Highly wear resistant tip materials	Significantly improved gate life
60% less heat loss to mold	Minimizes thermal defects in gate area
3.0mm min. tip OD	Small footprint enables tip to fit on a wide range of parts
Simplified mold maintenance	Gate is restored to new condition with tip replacement

Ultra Helix Valve Gate Technology

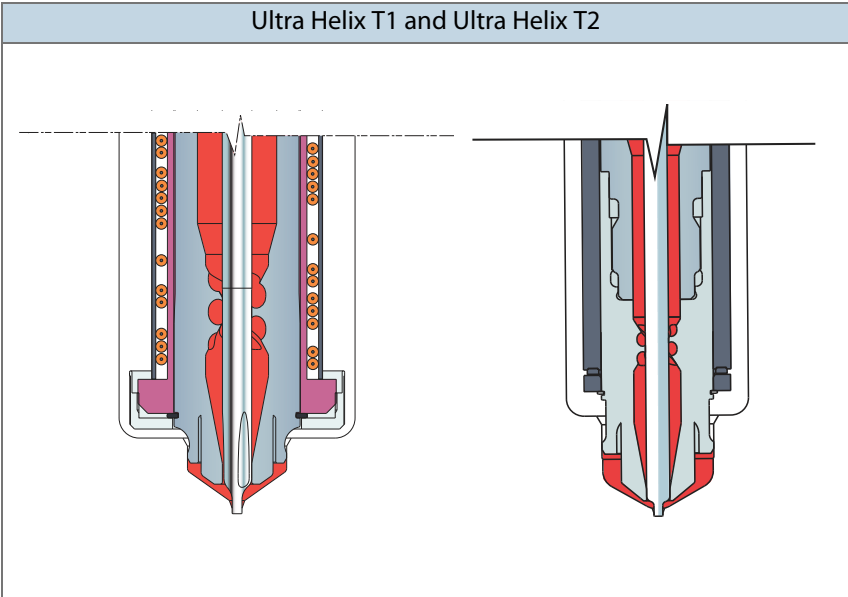

Feature	Benefit
Continuous valve stem guidance	Improved valve stem alignment with the gate
Nozzle heater closer to the gate	Better control of temperature in gate area
Integrated seal ring	More robust nozzle seal interface
Fits current Ultra gate detail	Retrofitable with existing cold halves without requiring rework
Two piece nozzle assembly (Ultra Helix T2)	Removable tip for ease of maintenance

Ultra Helix 250 T2 Nozzle Stack

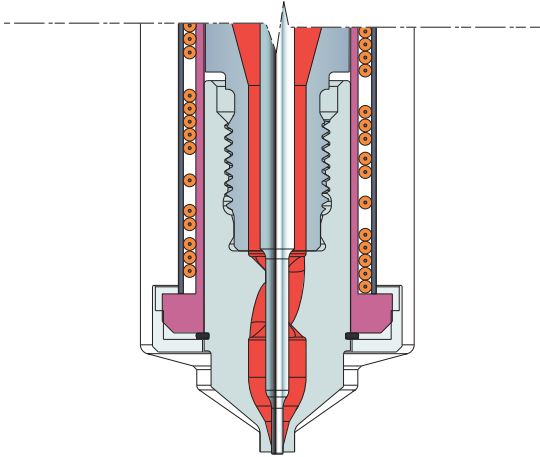
Ultra Helix VG	
	
Feature	Benefit
Ultra Helix technology	Industry leading gate quality and longevity
Two piece nozzle assembly	Removable tip for ease of maintenance
12mm nozzle bore	Difficult to access gate location solution
15mm min pitch spacing	Tightest achievable pitch spacing with Ultra Sync
Extended maintenance interval actuation design	Improved performance and reduced time for maintenance intervals in weepage prone applications
Ultra 250 HTM Gen II heater	Improved thermal profile and consistency

The Ultra Helix 250 T2 solution was specifically developed to extend the benefits of Ultra Helix valve gate technology for small part applications with difficult to access gate locations.

- Compatible with Individual pneumatic, Ultra Sync-P and Ultra Sync-E valve stem actuation options
- Tight pitch spacing down to 25.4mm with Individual pneumatic and 15mm with Ultra Sync
- PX pneumatic actuation offers advantages when compared to current LX standard in weepage prone applications
 - Improved thermal management and the addition of a stem seal significantly extends the maintenance interval for weepage prone resins like TPE and PE.
 - Valve stems can be individually accessed for maintenance without removing the backing plate
- Available in 0.8mm, 1.0mm and 1.2mm standard gate
- Direct gate on small weight part

Ultra Helix Packaging VG

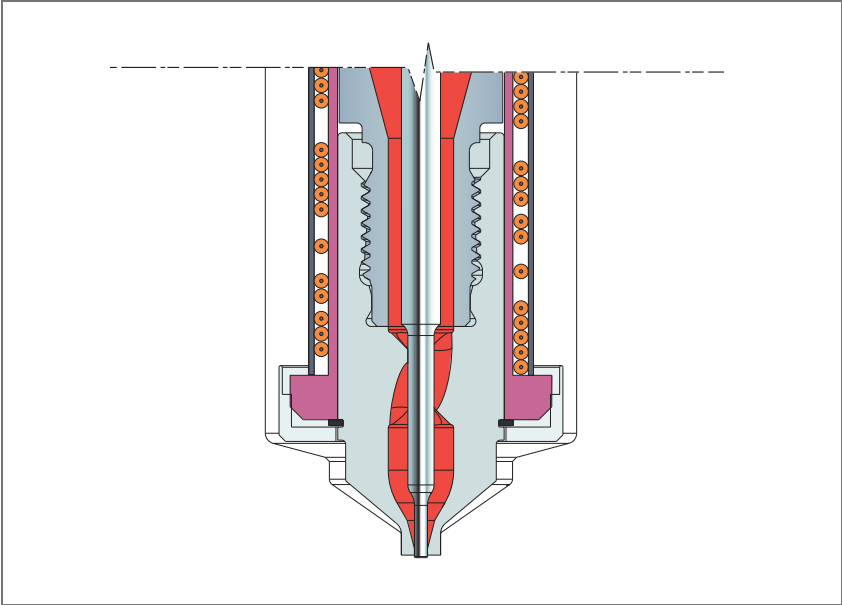

Feature	Benefit
All critical gate geometry contained within tip	Superior gate quality with no complex gate orifice finishing required
Stem guide integral with gate	Eliminates multiple tolerance stack ups
Highly wear resistant tip materials	Significantly improved gate life
5.0 mm OD Ultra Helix VG tip (U750) 4.0 mm OD Ultra Helix VG tip (U500)	Optimized thermal profile for short cycle times
Simplified mold maintenance	Gate is restored to new condition with tip replacement

The Ultra Helix Packaging VG tip was designed specifically for the unique demands of thinwall packaging applications. Contact Husky Sales Support for application assistance.

- Compatible with polyolefin resins only; polypropylene, polyethylene
- Available for Ultra Helix 750 and 500
- Available in 1.2mm, 1.5mm and 1.8mm gate.

Note: Tip outside diameter does not change with gate size like Ultra Helix VG. Contact Husky for gate detail.

- Compatible with high throughput and low cycle time applications typical of thinwall packaging

Ultra Helix 250 Valve Gate-Application Guidelines

Max Throughput (g/sec.)

		T2
Viscosity	Low	10
	Medium	4
	High	1

Material Compatibility

Resin	T2	Resin Structure
ABS	◇	A
PA	◇	SC
PBT	◇	SC
PC	◇	A
PC/ABS	◇	B
PE	✓	SC
PMMA	◇	A
POM	◇	SC
PP	✓	SC
PS	✓	A
SAN	◇	A
TPE	✓	A
TPO	✓	A
TPU	◇	A

Application Compatibility

Resin	T2
Abrasive	◇
Color Change	✓
Corrosive	◇
Metallic or Percent Pigments	◇

✓ – Recommended
SC – Semi-Crystalline

◇ – Requires Review
B – Blend

◇ – Not Recommended
A – Amorphous

Ultra Helix 350 Valve Gate-Application Guidelines

Max Throughput (g/sec.)

		VG	T1	T2
Viscosity	Low	20	20	20
	Medium	12	12	12
	High	5	5	5

Material Compatibility

Resin	VG	T1	T2	Resin Structure
ABS	✓	✓	✓	A
PA	◇	✓	✓	SC
PBT	◇	◇	◇	SC
PC	◇	◇	◇	A
PC/ABS	◇	◇	◇	B
PE	◇	✓	✓	SC
PMMA	◇	◇	◇	A
POM	◇	✓	✓	SC
PP	◇	✓	✓	SC
PS	◇	✓	✓	A
SAN	◇	◇	◇	A
TPE	◇	✓	✓	A
TPO	◇	✓	✓	A
TPU	◇	◇	◇	A

Application Compatibility

Resin	VG	T1	T2
Abrasive	◇	◇	◇
Color Change	✓	✓	✓
Corrosive	◇	◇	◇
Metallic or Percent Pigments	◇	◇	◇

✓ – Recommended

SC – Semi-Crystalline

◇ – Requires Review
B – Blend

◇ – Not Recommended
A – Amorphous

Ultra Helix 500 Valve Gate-Application Guidelines

Max Throughput (g/sec.)

	VG	T1	T2	
Viscosity	Low	20	20	20
	Medium	12	12	12
	High	10	10	10

Material Compatibility

Resin	VG	T1	T2	Resin Structure
ABS	✓	✓	✓	A
PA	◇	✓	✓	SC
PBT	◇	◇	◇	SC
PC	✓	✓	✓	A
PC/ABS	✓	✓	✓	B
PE	◇	✓	✓	SC
PMMA	✓	✓	✓	A
POM	◇	✓	✓	SC
PP	✓	✓	✓	SC
PS	✓	✓	✓	A
SAN	✓	◇	◇	A
TPE	✓	✓	✓	A
TPO	✓	✓	✓	A
TPU	◇	◇	◇	A

Application Compatibility

Resin	VG	T1	T2
Abrasive	◇	◇	◇
Color Change	✓	✓	✓
Corrosive	◇	◇	◇
Metallic or Percent Pigments	◇	◇	◇

✓ – Recommended

SC – Semi-Crystalline

◇ – Requires Review

B – Blend

◇ – Not Recommended

A – Amorphous

Ultra Helix 750 Valve Gate-Application Guidelines

Max Throughput (g/sec.)

		VG	T1	T2
Viscosity	Low	250	250	250
	Medium	150	150	150
	High	50	50	50

Material Compatibility

Resin	VG	T1	T2	Resin Structure
ABS	✓	✓	✓	A
PA	◇	✓	✓	SC
PBT	✓	✓	✓	SC
PC	◇	✓	✓	A
PC/ABS	◇	✓	✓	B
PE	◇	✓	✓	SC
PMMA	✓	✓	✓	A
POM	◇	✓	✓	SC
PP	✓	✓	✓	SC
PS	✓	✓	✓	A
SAN	✓	✓	✓	A
TPE	✓	✓	✓	A
TPO	✓	✓	✓	A
TPU	◇	◇	◇	A

Application Compatibility

Resin	VG	T1	T2
Abrasive	◇	◇	◇
Color Change	✓	✓	✓
Corrosive	◇	◇	◇
Metallic or Percent Pigments	◇	◇	◇

✓ – Recommended

SC – Semi-Crystalline

◇ – Requires Review

B – Blend

◇ – Not Recommended

A – Amorphous

Ultra 350 Valve Gate-Application Guidelines

Max Throughput (g/sec.)

	SCVG	VG	VX	
Viscosity	Low	20	20	20
	Medium	12	12	12
	High	5	5	5

Material Compatibility

Resin	SCVG	VG	VX	Resin Structure
ABS	✓	✓	◇	A
Flex. PVC	◇	◇	◆	A
PA	◇	◇	✓	SC
PA (33% GF)	◇	◇	✓	SC
PBT	◇	◇	◇	SC
PBT/PC	◇	◇	◇	B
PC	◇	◇	◇	A
PC/ABS	◇	◇	◇	B
PE	✓	✓	◆	SC
PEI	◇	◇	◇	A
PET	◇	◇	◇	SC
PETG	◇	◇	◇	A
PMMA	✓	✓	◇	A
POM	◇	◇	◆	SC
PP	✓	✓	◇	SC
PPO (PPE+PS/PA)	◇	◇	◇	A/SC
PS	✓	✓	◆	A
PSU	◇	◇	◇	A
SAN	◇	◇	◇	A
TPE	✓	✓	◆	A
TPO	✓	✓	◆	A
TPUR	◇	◇	◆	A

Application Compatibility

Resin	SCVG	VG	VX
Abrasive	◇	◇	✓
Color Change	✓	✓	✓

✓ – Recommended

SC – Semi-Crystalline

◇ – Requires Review

B – Blend

◆ – Not Recommended

A – Amorphous

- Recommended minimum air pressure is 6.8 bar [100 psi]
- For Ultra Helix information please see Ultra Helix section in Valve Gate Nozzle Stacks section

Ultra 500 Valve Gate-Application Guidelines

Max Throughput (g/sec.)

	SCVG	VG	VX	VG-X	VG-XX	VG-HP
Viscosity	Low	20	20	20	20	35
	Medium	12	12	12	12	-
	High	10	10	10	10	6

Material Compatibility

Resin	SCVG	VG	VX	VG-X	VG-XX	VG-HP	Resin Structure
ABS	✓	✓	◆	◇	◆	✓	A
Flex. PVC	◇	◇	◆	◆	◆	◆	A
PA	✓	✓	✓	◆	◆	✓	SC
PA (33% GF)	◇	◆	◇	◆	◆	✓	SC
PA (50% GF)	◆	◆	◆	◆	◆	◇	SC
PBT	◇	◇	◇	◆	◆	◆	SC
PBT/PC	◇	◇	◆	◆	◆	◆	B
PC	◇	◇	◆	◇	◇	◇	A
PC/ABS	✓	✓	◆	◆	◆	✓	B
PC/TPE	◆	◆	◆	◆	◆	✓	
PE	✓	✓	◇	◇	◇	◆	SC
PEI	◆	◇	◇	◆	◆	◆	A
PET	◇	◇	◇	◆	◆	◆	SC
PETG	◇	◇	◆	◆	◆	◆	A
PMMA	◇	✓	◆	◇	◆	✓	A
POM	◇	◇	◇	◆	◆	◆	SC
PP	✓	✓	◇	◇	◇	◆	SC
PPO (PPE+PS/PA)	◇	◇	◆	◆	◆	◆	A/SC
PS	✓	✓	◆	◆	◆	◆	A
PSU	◆	◇	◇	◆	◆	◆	A
SAN	◇	◇	◆	◆	◆	◆	SC
TPE	✓	✓	◇	◆	◆	◆	A
TPO	✓	✓	◇	◆	◆	◆	SC
TPUR	◇	◇	◆	◆	◆	◆	SC

Application Compatibility

Resin	SCVG	VG	VX	VG-X	VG-XX	VG-HP
Abrasive	◇	◆	✓	◆	◆	◆
Color Change	✓	✓	✓	◆	◆	◆

✓ – Recommended ◇ – Requires Review ◆ – Not Recommended
 SC – Semi-Crystalline B – Blend A – Amorphous

- Recommended minimum air pressure is 6.8 bar [100 psi]
- For Ultra Helix information please see Ultra Helix section in Valve Gate Nozzle Stacks section

Ultra 750 Valve Gate-Application Guidelines

Max Throughput (g/sec.)

	SCVG	VG	VX	VG-R	VG-UF	
Viscosity	Low	250	250	250	250	175
	Medium	150	150	150	150	80
	High	50	50	50	50	40

Material Compatibility

Resin	VG	VX	VG-R	VG-UF	Resin Structure
ABS	✓	✓	◇	◇	A
CAB	◇	◆	◆	◆	A
Flex. PVC	◇	◆	◆	◆	A
PA	✓	✓	◆	◆	SC
PBT	✓	◇	◆	◆	SC
PBT/PC	◇	◇	◆	◆	B
PC	◇	✓	◇	◇	A
PC/ABS	✓	◇	◆	◆	B
PE	✓	◇	◇	◇	SC
PEI	◆	◇	◆	◆	A
PET	◇	◆	◇	◆	SC
PETG	◇	◇	◇	◆	A
PMMA	✓	◆	◆	◆	A
POM	◇	◇	◆	◆	SC
PP	✓	◇	◇	◇	SC
PPO(PPE+PS/PA)	◇	◇	◆	◆	A/SC
PPS	◇	◇	◆	◆	SC
PS	✓	◆	✓	◇	A
PSU	◇	◇	◆	◆	A
SAN	✓	✓	◆	◆	A
TPE	◇	◇	◇	◇	A
TPO	◇	◇	◇	◇	A
TPUR	◇	◇	◆	◆	A

Application Compatibility

Resin	VG	VX	VG-R	VG-UF
Abrasive	◆	✓	◆	◆
Color Change	✓	✓	◆	◆

✓ – Recommended ◇ – Requires Review ◆ – Not Recommended
 SC – Semi-Crystalline B – Blend A – Amorphous

- Recommended minimum air pressure is 6.8 bar [100 psi]
- For Ultra Helix information please see Ultra Helix section in Valve Gate Nozzle Stacks section

Ultra 1000 Valve Gate-Application Guidelines

Max Throughput (g/sec.)

	VG	VX	VX-X	
Viscosity	Low	450	450	450
	Medium	200	200	200
	High	80	80	80

Material Compatibility

Resin	VG	VX	VX-X	Resin Structure
ABS	✓	✓	✓	A
PA	◇	✓	✓	SC
PA(GF)	◇	✓	✓	SC
PBT	✓	✓	✓	SC
PBT/PC	✓	✓	✓	B
PC	✓	✓	✓	A
PC/ABS	✓	✓	✓	B
PE	✓	✓	◇	SC
PETG	◇	◆	◆	A
PMMA	✓	✓	✓	A
POM	◇	◇	◇	SC
PP	✓	✓	✓	SC
PP (TALC)	✓	✓	✓	SC
PPO(PPE+PS/PA)	✓	✓	✓	A/SC
PS	✓	✓	✓	A
SAN	✓	✓	✓	A
TPE/TPO	✓	◇	◇	A

Application Compatibility

Resin	VG	VX	VX-X
Abrasive	◇	✓	✓
Color Change	✓	✓	✓

✓ – Recommended ◇ – Requires Review ◆ – Not Recommended
 SC – Semi-Crystalline B – Blend A – Amorphous

- Wear resistant tips required for process temperature above 325°C [617°F] and resins with an abrasive filler i.e. glass, mica, mineral, and carbon fiber
- Recommended minimum air pressure is 6.8 bar [100 psi]

Single Drops

Single Cavity Valve Gate (SCVG)

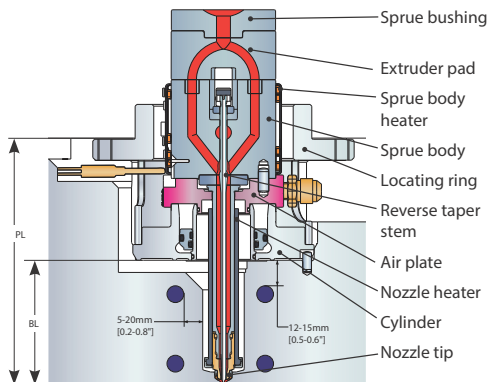

- Ideal for low volume or prototype purposes
- Available in Ultra 350, 500, 750 and 1000
- Available in Ultra Helix 350, 500 and 750
- Full range of valve gating options
- Temperature rating of 350°C [662°F] at a mold cooling temperature of 75°C [167°F]
(This temperature rating may be higher or lower depending on the mold cooling temperature. This temperature rating may also be less depending on specific nozzle tip; reference nozzle tip temperature ratings.)
- Max. Pressure is 1792 bar [26k psi]
- Stem Stroke added 7.3mm [0.29"]

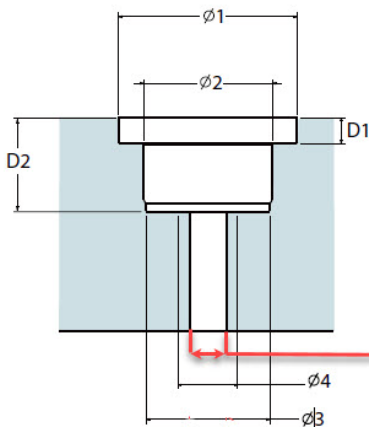

NOTE for SCVG:

- Preventative maintenance is required at 500K cycles
- Disassembly, clean resin deposits, seals inspection, inspect valve stem reverse taper seat and stem assembly for any noticeable wear
- All seals (static and dynamic) need to be replaced every one million cycles
- Installs direct into platen side of the 'A' side plates

Nozzle size	Ø1	Ø2	Ø3	Ø4	Min D1	Max D1	Min D2	Max D2	Min PL	Max Std PL	Max XL* PL	Min BL	Max Std BL	Max XL* BL
Ultra 350	150.0mm [5.906"]	108.0mm [4.25"]	104.04mm [4.096"]	50mm [1.969"]	12.28mm [0.483"]	21.85mm [0.866"]	69.5mm [2.736"]	79.07mm [3.113"]	95mm [3.74"]	244mm [9.60"]	N/A	25mm [0.98"]	165mm [6.49"]	N/A
Ultra 500	150.0mm [5.906"]	108.0mm [4.25"]	104.04mm [4.096"]	50mm [1.969"]	12.28mm [0.483"]	21.85mm [0.866"]	69.5mm [2.736"]	79.07mm [3.113"]	92mm [3.62"]	200mm [7.87"]	330mm [12.99"]	22mm [0.86"]	121mm [4.76"]	260mm [10.23"]
Ultra 750	150.0mm [5.906"]	108.0mm [4.25"]	104.04mm [4.096"]	50mm [1.969"]	12.28mm [0.483"]	21.85mm [0.866"]	69.5mm [2.736"]	79.07mm [3.113"]	108mm [4.25"]	215mm [8.46"]	335mm [13.18"]	39mm [1.53"]	138mm [5.43"]	265mm [10.43"]
Ultra 1000	170mm [6.693"]	134mm [5.28"]	130.04mm [5.120"]	70mm [2.756"]	12.25mm [0.482"]	21.85mm [0.866"]	87.55mm [3.447"]	97.15mm [3.825"]	125mm [4.92"]	245mm [9.64"]	N/A	37mm [1.45"]	157mm [6.18"]	N/A
Ultra Helix 350	150.0mm [5.906"]	108.0mm [4.25"]	104.04mm [4.096"]	50mm [1.969"]	12.28mm [0.483"]	21.85mm [0.866"]	69.5mm [2.736"]	79.07mm [3.113"]	95mm [3.74"]	244mm [9.60"]	N/A	25mm [0.98"]	165mm [6.49"]	N/A
Ultra Helix 500	150.0mm [5.906"]	108.0mm [4.25"]	104.04mm [4.096"]	50mm [1.969"]	12.28mm [0.483"]	21.85mm [0.866"]	69.5mm [2.736"]	79.07mm [3.113"]	92mm [3.62"]	200mm [7.87"]	330mm [12.99"]	22mm [0.86"]	121mm [4.76"]	260mm [10.23"]
Ultra Helix 750	150.0mm [5.906"]	108.0mm [4.25"]	104.04mm [4.096"]	50mm [1.969"]	12.28mm [0.483"]	21.85mm [0.866"]	69.5mm [2.736"]	79.07mm [3.113"]	108mm [4.25"]	215mm [8.46"]	335mm [13.18"]	39mm [1.53"]	138mm [5.43"]	265mm [10.43"]

* Please note there is a longer lead time for XL dimensions

Single Drops-SCVG

Configure to Order (CTO) vs Engineering to Order (ETO)

CTO:

- Shorter lead time
- 2D installation drawings available on-line prior to order
- 3D model, gate details and BOM available within 24hrs of order and complete information for a project
- More competitive price
- Only standard components

ETO:

- Custom nozzle lengths available
- Can support more demanding applications such as corrosive resins
- Standard and custom components

CTO Offerings

Product	Nozzle Series	Sprue Inlet Diameter	Gating Style	Nozzle Housing Length [mm]
SCVG	U350	4*, 8	VG, VX, UH-VG	55,65...185,195
	U500	4*, 8	VG-GP, VX, UH-VG	50,60...190,200
	U750	6.35*, 11.5	VG-GP, VX, UH-VG, VG-R	50,60...190,200
	U1000	11.5	VG, VX	70,90...170,190

** Only available with flat radius*

- Please refer to on-line drawings for BL and PL values
- Sprue seal off type (mm): flat, 12.7, 15.5, 19.05, 20, 40
- Locating ring (mm): 100, 101.3 (3,99"), 125
- Standard electrical connectors and electrical box adapter available as paid options

Ultra 500 HP - High Pressure (VG/VX)

Ideal for Technical and Consumer electronics parts

- For pressures from 26k psi to 43.5k psi

Pressure Range	Tip Style	
	VG HP	VX HP
From 26k psi to 33k psi	✓	✓
From 33k psi to 43.5k psi	X	✓

- Compatible with standard LX or EX valve stem actuation or with SSA (Staggered Stem Actuation) for high pressure and close pitch
- Single piece VG housing/tip (housing and tip is a 2 piece design for VX)
- High strength steel housings
- High force spring package

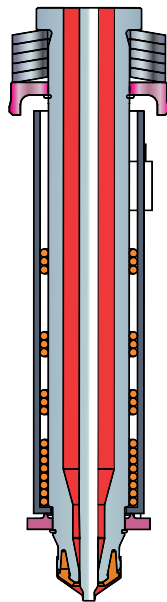

Staggered Stem Actuation

- 250 lbs. stem force (compared to 150lbs. on LX)
- Pitch spacing as low as 28mm [1.10"]
- Enables 2 drops per cavity on small parts
- Sequential gating option
- Compatible with Ultra 500 VG/VX nozzles only
- Standard system shutheight (ie. Min. 60mm [2.36"] thick backing plate)

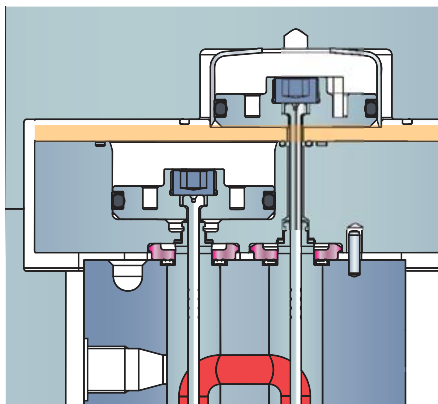

Valve Gate Air Circuit Recommendations and Machine Setup

The following are a set of recommendations that should be given to all customers purchasing a pneumatically actuated Husky Hot Runner. These are recommendations only; they are to get the best possible performance out of a pneumatically actuated valve gated Husky Hot Runner

- No more than 36 cavities/nozzles per air circuit
- Air supply should be clear and dry at a pressure between 80-120 psi [550-830 kPa]
 - For thinwall parts and engineering resins the pressure should be between 100-120 psi [690-830 kPa]
- A four-way air solenoid should be on the machine for every air circuit in the hot runner
- Example: If Hot Runner has four separate air circuits, the machine should have four separate air solenoids controlling the four air circuits
- Quick exhaust valves should be installed on both air lines to increase the speed at which the stems open and close
- For air circuits with less than 24 cavities/nozzles, the air solenoids must have a minimum Cv valve of 1.5. If the air circuit is greater than or equal to 24 cavities/nozzles, then the machine solenoid must have a minimum Cv value of 3.0 (Standard Husky Machine value has Cv of 1.5)
- If using a solenoid that has a Cv less than 3.5, regardless of number of cavities/ nozzles a quick exhaust should be installed
- The flow rate of air coming out of each machine solenoid should be at a minimum of 0.625 standard cubic feet per minute (scfm) per drop. This should be measured with air flowing through all of the solenoids on the machine at the same time
- Air hoses running from the machine solenoids to the Hot Runner should have an internal diameter no smaller than 9.525mm [3/8"], and no larger than 19.05mm [¾"]
- Air hoses should be as short as possible with a maximum length of 1.83m [6'], and should all be the same length
- 13.8bar [200psi] air pressure may be required for proper operation of SX valve gated systems
- Insufficient air pressure provided to SX piston can lead to stems seizing, sticking, and/or posting on the molded part
- Use a Husky Air Kit for optimal performance

In this section:

Page

3-1	Overview
3-2	UltraSync — Technology Comparison
3-3	UltraSync-E
3-5	UltraSync-H
3-6	UltraSync-P
3-7	UltraSync-E with Altanium Controller

Overview

Benefits

- 100% synchronized valve stem movement
 - Stems are connected to an actuation plate
- Improved shot to shot and cavity to cavity consistency
- Minimum drop to drop pitch spacing (18mm, [0.709"])* with no sacrifice of closing force
- Simple installation and maintenance
- Increased process control with plate position sensing option

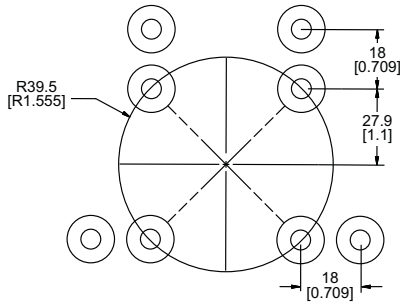

PITCH SPACING FOR U350 VG

Features

- Electric, pneumatic, and hydraulic actuation options**
- Pitch spacing is the same for all three actuation methods
- Available for Ultra 350, 500, 750 and Ultra Helix 250, 350, 500, 750 nozzles with the same gating options as individual pneumatic actuation

Features	Individual	Plate Actuated
Constant stem force – PX, SX, LX, EX	X	✓
Close pitch availability 18mm [0.70"]*	X	✓
EX stem force	✓	✓
In-machine maintenance and stem removal	✓	✓
Automatic gate protection	X	✓
Clean room environment acceptance	✓	✓
Extended gate and component life	X	✓
Energy savings	X	✓
Sequential Gating	✓	X
Cold start protection	X	✓
Stem Shut-off —Taper or Plunger	Both	Plunger only

*15mm (0.59") pitch spacing achievable with Ultra Helix 250

** Hydraulic actuation not available with Ultra Helix 250

UltraSync — Technology Comparison

Description	Hydraulic	Pneumatic	Electrical
Repeatable shot-to-shot consistency	✓	✓	✓
Constant stem force	✓	✓	✓
Close pitch availability 18mm [0.70"]*	✓	✓	✓
In-machine maintenance and stem removal	✓	✓	✓
Clean room environment acceptance	X	✓	✓
Valve stem protrusion control	X	X	✓
Valve stem velocity profiling	X	X	✓
Extended gate and component life	X	X	✓
Energy savings	✓	X	✓
Altanium controller integration	X	X	✓
Minimum shutheight (Increase over individual VG)	✓	✓	✓
Minimal or no change to plate size (HxW)	✓	✓	X

UltraSync-E

Benefits

- Up to a 5X extension of gate and stem longevity
 - Motion control minimizes the force exerted on stem and gate orifice when valve stems close
- Improved initial gate vestige quality and quality over time
- Closed loop control of stem motion, force, and position
- Cleanest valve gate technology available
- Reduced energy consumption
- Lowest total cost of ownership compared to any VG technology

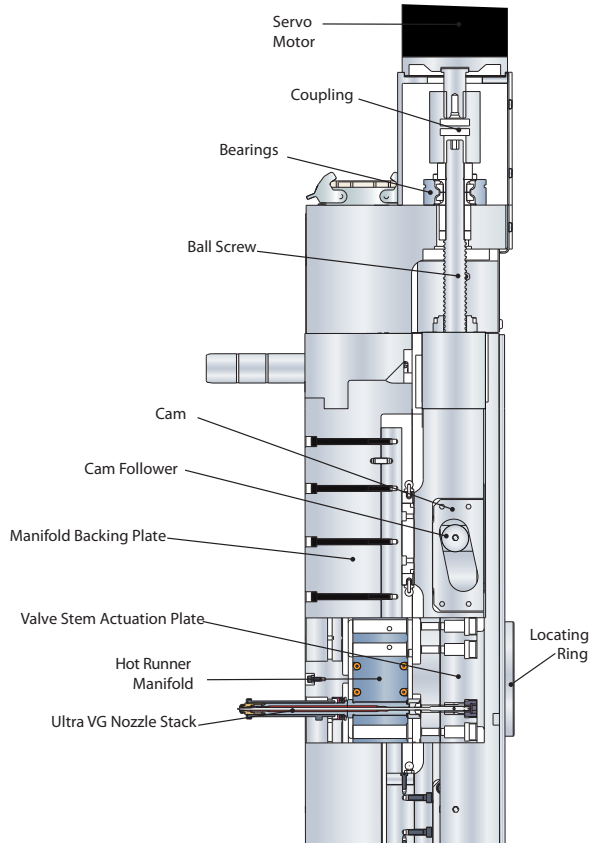

Features

- **Must be sold with an Altanium controller**
 - Important molder information on connecting controller to the IMM is available from Husky
- Fewer moving parts compared to any other VG technology
- In press lubrication
- Valve stem protrusion adjustability
- Stem pull back before the mold opens
- Shut height increase of 35-50mm [1.35"-1.97"]

UltraSync-E

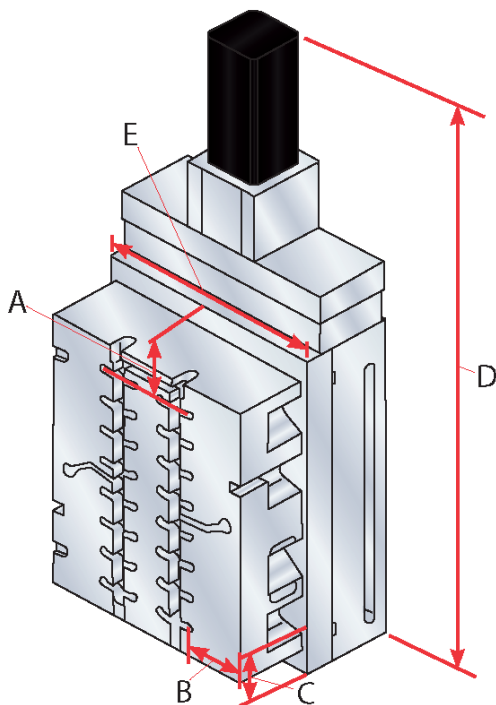

UltraSync E Plate And Space Requirements

Dimension	Description	2-64 Drops	72-128 Drops
A	Top row of drops to edge of manifold plate	100mm [3.93"]	100mm [3.93"]
B	Outer column of drops to side edge of manifold plate	125mm* [4.92"]	160mm [6.29"]
C	Bottom row of drops to edge of manifold plate	100mm [3.93"]	100mm [3.93"]
D	Minimum assembly height	815-900mm [32"-35.4"]	1165mm [45.8"]
E	Minimum assembly width	300mm [11.8"]	408mm [16"]

* With clamp slots only. Direct bolting or additional cut outs require review
 Contact Husky factory for motor mounting on side or bottom

UltraSync-H

Benefits

- Plate size similar to individual VG
- Minimal shutheight increase over individual pneumatic VG, as low as 20mm [0.79"]
- Only requires one hydraulic core function from the IMM

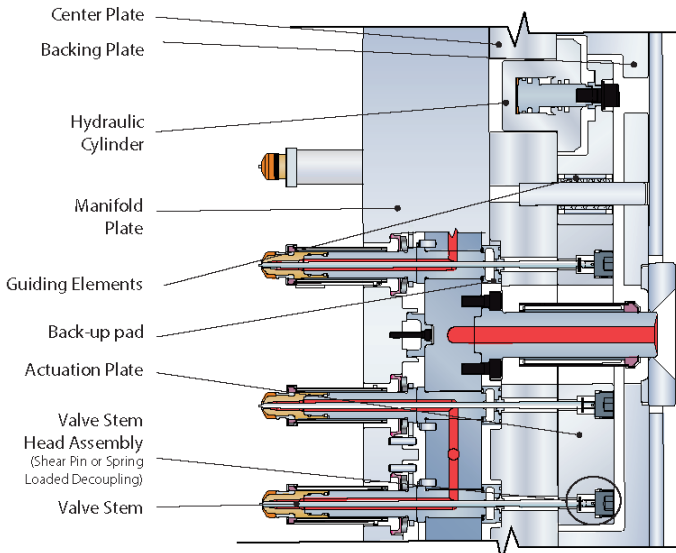

Features

- No separate controller is required. The customer needs to have one hydraulic core function or one hydraulic valve gate function available (one outlet for opening and one outlet for closing)
- UltraSync H is not recommended for customers that do not have experience managing hydraulic fluid in their molding areas
- Uses more robust (leak resistant) hydraulic cylinders than the original design

UltraSync-P

Benefits

- Same set-up and operation as individual VG system including air flow and pressure requirements
- Clean room compatibility
- Only requires one pneumatic valve gate
- Easy cylinder seal replacement without HR disassembly

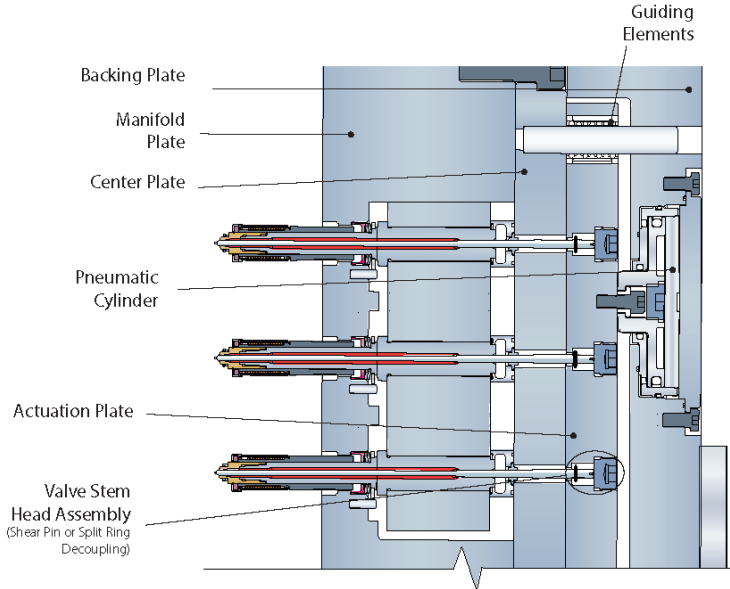









Features

- No separate controller is required
- Air functions the same as individual VG actuation
- Multiple sized cylinders are available for more pitch flexibility
- Increased shut height compared to individual VG 30-50mm [1.18"-1.96"]

UltraSync-E with Altanium Controller



Configuration	Cavities	Operator Interface	Enclosure Layout
Low Cavity Single Axis (With or w/o Heats)	2 - 64	Delta5 or Matrix5 	Integrated or Standalone 
Low Cavity Dual Axis (With or w/o Heats)	2 - 64 per HR	Matrix5 Only 	Integrated or Standalone 
Low Cavity Single Axis (With or w/o Heats)	>64 - 128	Matrix5 Only 	Integrated or Standalone 
Low Cavity Dual Axis (With or w/o Heats)	>6 - 128 per HR	Matrix5 Only 	Integrated or Standalone 

UltraSync-E with Altanium Controller

Benefits of Integrated Temperature and Servo Control

- Simple setup, control and monitoring using a single screen instead of two
- Less floor space – only one control unit required
- Cost savings – only one interface required
- Valve stem position, force and speed control
- Valve stem control parameters are saved to a mold setup for easy recall
- Integrated damage protection – if temperatures are not at setpoint, stem motion is prohibited
- Process data logging – open/close time, open/close position and peak open/ close force

Controller Interface with Machine

- Interface signals are provided via a supplied cable that connects to the controller with color codes flying leads on the IMM end
- The following signals are required for stem operation:
- Integrated Temperature + UltraSync-E Control
 - E-Stop of IMM
 - IMM Safety Gates Closed
 - Open Valve Stems
 - Close Valve Stems (If configured)
- Standalone UltraSync-E Control
 - E-Stop of IMM
 - IMM Safety Gates Closed
 - External At-Temperature
 - Open Valve Stems
 - Close Valve Stems (If configured)
- Available Process Outside Limits output to the IMM – cable to be purchased separately
- Bench mode connector plug available for operation without IMM interface

UltraSync-E with Altanium Controller

Controller Valve Stem Operation Screen

- All screens provide access to the following:
 - Control Mode Buttons: Manual, Disable and Auto controls
 - Command Buttons: Close, open and calibrate controls
 - Status Field: Displays current active command and plate position



Displays indicators for all ready conditions and position, force and fault statuses as well as the manual controls for open and close and calibration

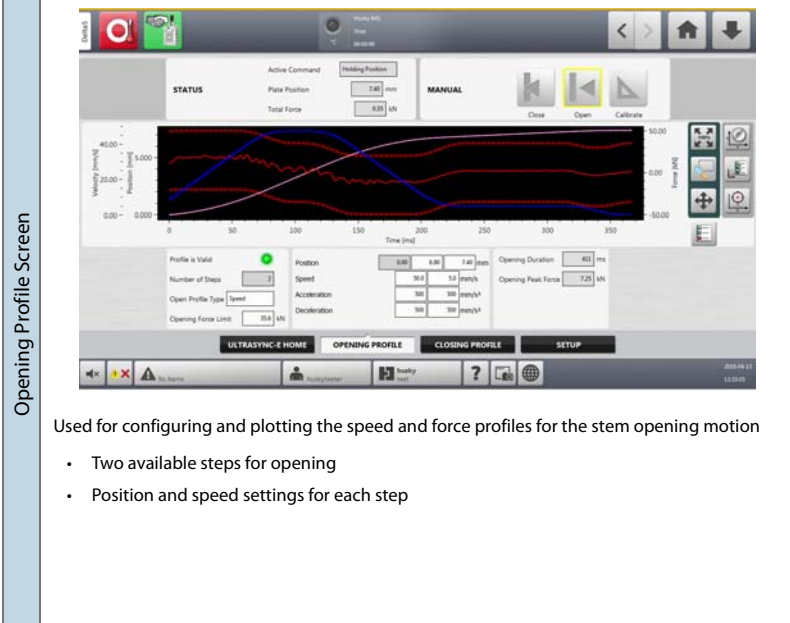

UltraSync-E with Altanium Controller

Controller Valve Stem Operation Screen

Closing Profile Screen



Used for configuring and plotting the speed and force profiles for the stem closing motion

- Three available steps for closing
- Position and speed settings for each step
- Settings for closing hold force

Setup Screen



Used to set the At-temp soak time, Relax force limit, Relax delay time, behavior after calibration, and configuring values for At-Position and Position Alarm Window monitoring functions as well as accessing other screens for configuring engaged mode commands and conditions for signals used for permitting calibration or disengaging, configuring the maintenance position on Gen 1 systems, setting up the stem pullback position and selecting the number of cavities and motor type.

In this section:

Page

4-1Overview

4-2Features

4-3Technology Comparison

4-4Benefits

4-5ISVG with Altanium Controller

Overview



Individual Servo Valve Gate (ISVG)

Complete valve stem motion control for improved molded part quality and consistency

- Individual valve stem electric servo actuation
- 100% synchronized valve stem movement
- Profiled motion for each valve stem
- Improved shot to shot and cavity to cavity consistency
- Sequential gate opening and closing
- Compact size servo actuator design to minimize shut height
- Available in Hot Runner and Manifold System configurations
- Must be sold with an Altanium ISVG controller

Features

Low Cavitation - Up to 8 Drops

- Gating styles available - VG, VX, Ultra Helix VG/T1/T2
- Plunger only

Nozzle Sizes Available

- Ultra 350, 500, 750
- Ultra Helix 350, 500, 750

Applications where LX and EX valve stem actuation would be used

Ability to process with part fill pressure up to 179.2 MPa [26K psi] and mold temperature up to 100°C

Max melt temperature 340°C

- Stem stroke up to 9.5mm (0.37")
- Valve stem position adjustment +/- 0.01 mm
- Maximum 100mm/sec (3.94in/sec) speed
- Dependent on the stroke and profile setup

Shut Height

- Minimum shut height 220mm (8.66")
- Overall plate dimensions approximately half of equivalent UltraSync-E
(See dimensions on page 4-2)

Pitch Spacing

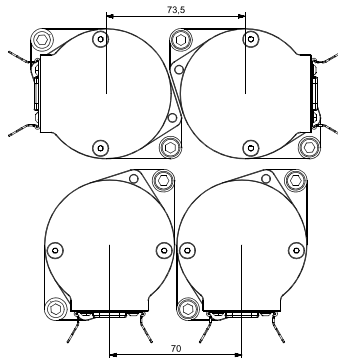

Technology Comparison

Material Compatibility

Description	ISVG	UltraSync-E
Repeatable shot-to-shot consistency	✓	✓
Constant stem force	✓	✓
Valve stem velocity profiling	✓	✓
Valve stem protrusion control	✓	✓
Sequential gating	✓	✓
Independent gate open/close	✓	✓
Individual stem shut off	✓	✓
Minimum pitch	70mm (2.76")	18mm (0.71")
In-machine maintenance and stem removal	✓	✓
Automatic gate protection	✓	✓
Clean room environment acceptance	✓	X
Extended gate and component life	✓	✓
Energy savings	✓	✓
Cold start protection	✓	✓
Stem shut off	Plunger only	Plunger only
Altanium controller integration	✓	✓

Benefits

- Extension of gate and stem longevity reducing downtime and maintenance costs
 - Valve stem velocity profiling minimizes the force exerted on the stem and gate orifice at close
 - When matched with Ultra Helix valve gate technology significantly extends gate and stem life
- Closed loop control of stem motion, force and position
 - Immediate valve stem response to signal
 - Precise and repeatable valve stem positioning
 - Traceable proof of valve stem motion
- Synchronized actuation improves balance and part quality repeatability
- Independently gate opening and closing
 - Sequential actuation with greater precision and faster response time provides greater control and flexibility than pneumatic or hydraulic options
 - Two-shot molding - Open and close each stem based on injection unit
 - Family molding fill control - balance different part weights
 - Multi-gate molding - Control of flow front from each gate for precise and repeatable weld line positioning and cavity balance control
 - Multi-material or large parts can be molded with valve stem sequencing.
- Valve stem protrusion adjustability
 - Each valve stem can be individually calibrated to minimize the protrusion without impact to gate quality
 - Protrusion can be adjusted during operation
- Individual stem shut off
- Cleanest valve gate technology available

ISVG with Altanium Controller



Matrix5 ISVG controller available in two configurations

- Standalone = ISVG control only
- Integrated = ISVG control + Hot runner temperature

(Both configurations available in 4 or 8 axis options - 1 axis controls 1 valve stem)

Features

- Setup valve stems to run in synchronized mode or sequential mode
- Opening and Closing profile screens for setting stem position, speed, acceleration and deceleration and viewing graphs of individual stem profiles
- Historical and run-time charts for process data logging open/close time, open/close position and peak open/close force for up to 100,000 cycles
- Cycle graph screen for viewing an overlay of all stem motion for the full cycle
- Integrated At-Temperature feature to prevent stem actuation until mold is up to temperature
- 22 user configurable digital inputs and 15 user configurable digital outputs for triggering valve stem movement and interlocks to the IMM
- 8 user configurable analog inputs for sequencing off IMM screw position or other analog instrumentation in the mold
- 2 channel safety relays for E-Stop and Safety Gate signals
- Bench mode plug for servicing HR outside the IMM
- Change air filter reminder feature with enclosure overtemperature alarm
- Security features to lock out functionality at login based on user permissions
- Optional linear position transducer (LPT) available for triggering stem motion based on IMM screw position

Benefits of Integrated Temperature and Servo Control

- Simple setup, control and monitoring using a single operator interface
- Less floor space - only one control unit required
- Cost savings - only one interface required
- Control speed, stroke, force and time of valve stem actuation to reduce mechanical stress on the mold and extend gate life
- Valve stem control parameters and heat setpoints are saved to a mold setup for easy recall
- Integrated damage protection - If mold temperatures are not at setpoint, stem motion is prohibited
- Monitor servo performance and alarms for force, speed and position deviations for immediate notification if anything goes out of specification
- Servo actuator over temperature protection to prevent damage to servo motor
- Position, duration and force data collection for up to 100,000 cycles providing instant access to stem motion performance for troubleshooting and part quality tracking
- Technology gives molders the ability to determine which area of a cavity fills first and how quickly, delivering unprecedented control over weld or knit line positioning
- Other benefits include mechanical balancing of family molds and ability to use a progressive fill technique

Controller Interface with Machine

Interface signals are provided through supplied X200 and X201 cables with flying leads on the IMM end

The following signals are required for stem operation:

- Integrated Temperature + ISVG control
 - E-Stop of IMM (2 Channel)
 - IMM Safety Gate (2 Channel)
 - Open Valve Stems signal
 - Close valve stems (If configured)
- Standalone ISVG control
 - E-Stop of IMM (2 Channel)
 - IMM Safety Gate (2 Channel)
 - External At-Temperature
 - Open Valve Stems
 - Close valve stems (If configured)

Bench mode connector included for operation when not connected the IMM interface
Optional analog input cable available

ISVG with Altanium Controller

Controller Valve Stem Operation Screens

The individual servo valve gate controller screens give you operational control of the following:

- Set operation of one or more axes
- Put axes into groups
- Enter user-specified names of axes and groups
- Calibrate one or more axes
- Control manual axis movement
- Set limits for axes (minimum/maximum positions, target positions, speeds, acceleration/deceleration)
- Monitor open and close profiles
- View and change motion profiles

ISVG Home Screen

The screenshot displays the ISVG Home Screen interface. At the top, there is a status bar with a 'Status' section showing 'Spin Time Complete' and 'Ready for Axis Move'. Below this is a 'Manual Control' section with buttons for 'Close', 'Open', and 'Calibrate'. The main area contains a table for 'G1' with columns for 'Enabled', 'Cntrl', 'Axis State', 'Force', 'Position', and 'Control'. The table lists eight axes (ISVG Axis 1 through 8) with their respective force and position values. At the bottom, there are buttons for 'ISVG HOME', 'CYCLE', 'OPEN PROFILE', 'CLOSE PROFILE', 'SEQUENCE', and 'SETUP'. A footer line provides model, serial, and software version information.

The ISVG Home screen gives high-level information of each axis, which includes the following:

- Status, current force, and current position
- A graphical indicator shows the axes' positions as they cycle
- Command buttons to manually calibrate, open, and close each axis

ISVG with Altanium Controller (continued)

Controller Valve Stem Operation Screens

ISVG Setup Screen



The screenshot displays the ISVG Setup Screen interface. The screen is divided into several sections:

- AT TEMPERATURE:** Includes fields for 'At Temperature', 'At Temperature Skat Time', 'Skat Time Remaining', and 'Skat Time Complete'.
- PRESET AUTO MODE:** Shows 'All Servo Calibrated', 'No Faults', and 'Ready for Auto Mode' with green status indicators.
- GROUP NAMES:** A list of four groups (Group 1 to Group 4) with corresponding input fields for names.
- HOT RUNNER CONFIGURATION:** A section with a 'Test Configuration' button and an icon of a hot runner.
- AUTO SEQUENCE:** Includes 'Auto Sequence Skat Trigger', 'Auto Sequence Running', and 'Auto Sequence Duration'.

At the bottom of the screen, there are navigation buttons: 'SERVO HOME', 'CYCLE', 'OPEN PROFILE', 'CLOSE PROFILE', 'SEQUENCE', and 'SETUP'. A taskbar at the very bottom shows system icons and a clock.

The ISVG Setup screen is used to configure the servo axes, which includes the following:

- Activate or deactivate one or more axes
- Enter user-selected names for the axis groups
- Monitor the necessary conditions that let the system be changed to Auto mode
- Set user-configured trigger that lets the system start the auto sequence

ISVG with Altanium Controller (continued)

Controller Valve Stem Operation Screens

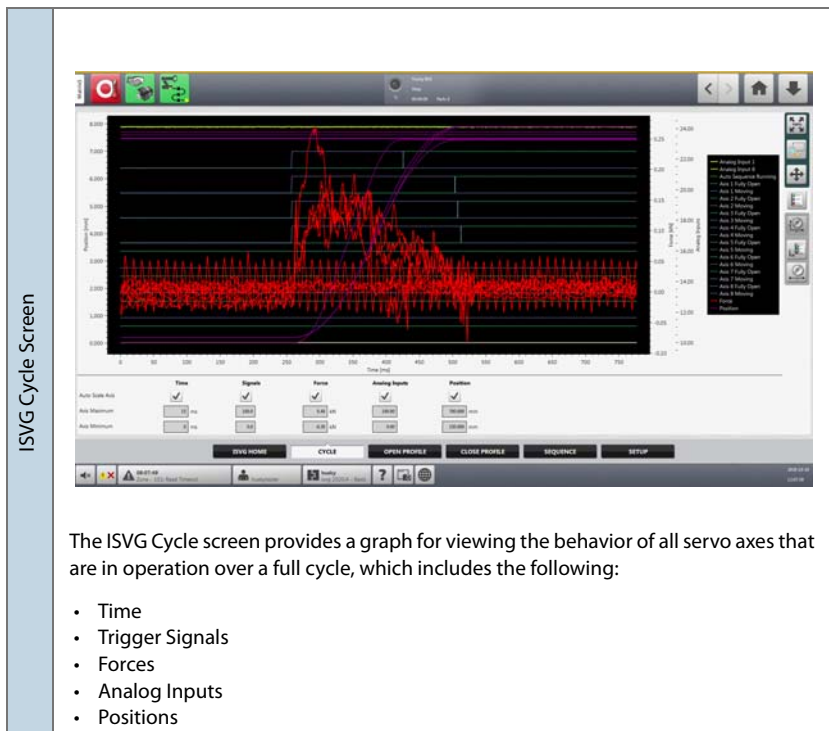

ISVG with Altanium Controller (continued)

Controller Valve Stem Operation Screens

ISVG Open Profile Screen

The screenshot displays the ISVG Open Profile screen. At the top, there is a navigation bar with icons for Home, Back, and Forward. Below this is a menu bar with tabs for ISVG Box 1 through ISVG Box 8. The main area features a graph with a white line representing the valve stem position over time, overlaid with a blue profile curve. The graph has two y-axes: the left axis is labeled 'Position (mm)' and ranges from -0.0020 to 0.0020; the right axis is labeled 'Velocity (mm/s)' and ranges from -2.00 to 2.00. The x-axis is labeled 'Time (ms)' and ranges from 0 to 250. Below the graph are four configuration panels: 'PROFILE SETTINGS' (Profile Type, Profile Velocity, Force Warning Level), 'POSITION' (Open Position, Open Velocity), 'PROFILE' (Profile, Speed, Acceleration, Deceleration), and 'PROCESS VALUES' (Custom Values, Actual Position, Peak Force). At the bottom, there are buttons for ISVG HOME, CYCLE, OPEN PROFILE, CLOSE PROFILE, SEQUENCE, and SETUP. A status bar at the very bottom shows system information like 'SERVO 1 OK' and 'SERVO 2 OK'.

The ISVG Open Profile screen is for configuring the open profile for all or selected valve gates, which includes the following:

- Three available steps for opening
- Position, speed, acceleration and deceleration settings for each step
- Force warning level setting for the opening profile

ISVG with Altanium Controller (continued)

Controller Valve Stem Operation Screens

ISVG Close Profile Screen



The screenshot displays the ISVG Close Profile screen. At the top, there is a navigation bar with icons for home, back, and forward. Below this is a menu bar with options for 'ISVG Home', 'Cycle', 'Open Profile', 'Close Profile', 'Sequence', and 'Setup'. The main area features a graph with three data series: Position (blue line), Speed (red line), and Acceleration (white line) plotted against Time (ms). The Position axis ranges from -0.0050 to 0.0050, the Speed axis from -2.00 to 2.00, and the Acceleration axis from -10000 to 10000. Below the graph are four configuration sections: 'PROFILE SETTINGS' (Profile Type, Profile Name, Force Warning Level), 'POSITION' (Position, Close Position, Peak Offset), 'PROFILE' (Profile, Speed, Acceleration, Deceleration), and 'PROCESS VALUES' (Custom Values, Actual Position, Peak Force). At the bottom, there is a status bar with system information and icons.

The ISVG Close Profile screen is for configuring the close profile for all or selected valve gates, which includes the following:

- Three available steps for closing
- Position, speed, acceleration and deceleration settings for each step
- Force warning level setting for the closing profile

ISVG with Altanium Controller (continued)

Controller Valve Stem Operation Screens

ISVG Sequence Profile Screen



The screenshot displays the ISVG Sequence Profile Screen, which is used to configure the sequence of open and close movements for each axis. The screen features a table with columns for Axis, Move, Signal Type, Signal Source, Condition, Value, Unit, Type, Delay Time, and Delay. The table lists operations for axes ISVG Axis 1 through ISVG Axis 8, including Open and Close moves. The bottom of the screen has navigation buttons: ISVG HOME, CYCLE, OPEN PROFILE, CLOSE PROFILE, SEQUENCE, and SETUP.

The ISVG Sequence screen is used to configure the sequence of the open and close movements of each axis, which includes the following:

- Trigger signals, sources and conditions
- Trigger behavior type and Delay times
- Other setpoints that start the open/close movement operations for all axes

In this section:

Page

5-1	Key Advantage
5-2	Hot Tip Gate Quality Guidelines
5-3	Product Matrix
5-5	Gate Detail Dimensions
5-8	Pitch Spacing
5-10	Ultra 250 Hot Tip-Application Guidelines
5-11	Ultra 350 Hot Tip-Application Guidelines
5-12	Ultra 500 Hot Tip-Application Guidelines
5-13	Ultra 750 Hot Tip-Application Guidelines
5-14	Ultra 750 UP-Application Guidelines
5-15	Ultra 1000 Hot Tip-Application Guidelines
5-16	Single Drops-Hot Sprue
5-18	Energy Savings Package (ESP) for Closures Hot Runners
5-19	Ultra 750 Ultra Packaging Nozzle (UP)

Key Advantage

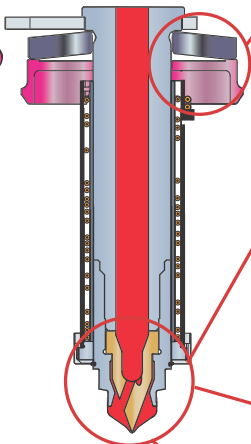
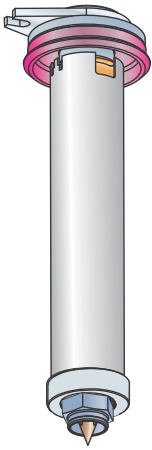

UltraSeal

- 3 yr. guaranteed leakproof operation
- Pre-loads nozzle to manifold
- Minimizes plate deflection /bowing

Wide Operating Window

- Wide temperature ranges without stringing or freeze-off
- Faster cycle times

Wear Resistant Tip Inserts

- Optional wear resistant tip for abrasive materials

Ease of Maintenance

- Tips, nozzle heaters & T/Cs eplaceable in the press





Hot Tip Gate Quality Guidelines

Factors Influencing Gate Quality		
Tip / Gate Variables	i. Tip style	
	ii. Tip position	
	iii. Tip land	
	iv. Gate diameter	
	v. Gate land	
	vi. Gate cooling	
Manifold Variables	Flow balance	
	Thermal balance	
	Melt channel sizing	
Processing Variables	Injection speed	
	Melt temperature	
	Mold temperature	
	Cooling time	
	Decompression	

Performance Guidelines		
Vestige	Semi-Crystalline Materials (POM, PA, PBT, PET, etc.)	Vestige Height = 1/3 Gate Diameter
	Amorphous Materials (PC, PS, ABS, PMMA, etc.)	Vestige Height = 1/2 Gate Diameter
	Filled and reinforced materials	Vestige Height=1/2 Gate Diameter or more
Stringing	5% - 10% Occurrence: HDPE, POM	
	10% - 15% Occurrence: PA, LDPE	
	15% - 20% Occurrence: PP, PS, PC, PMMA, ABS	
	General Guideline: Stringing can occur on any hot tip system 20% Occurrence with up to 3mm strings can be expected Risk of stringing increases with faster cycle times	

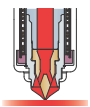
Product Matrix

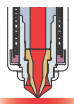
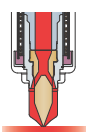
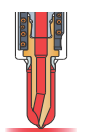
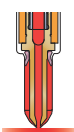
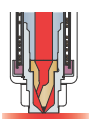
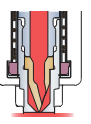
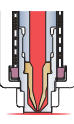
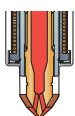
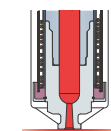
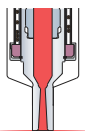
Gating Style			Application Overview	Ultra 250	Ultra 350	Ultra 500	Ultra 750	Ultra 1000
HT			General purpose thermal gate. Suitable for most resins. Three different tip styles available depending on the specific application (<i>all share common gate detail for each nozzle series</i>)	✓	✓	✓	✓	✓*
<u>D</u> iverted	<u>U</u> niverted	<u>T</u> hruflow						
								
HT-X (Extended)			Extended thermal gate for improved gate access. Three different tip styles available depending on the specific application (<i>all share a common gate detail for each nozzle series</i>)	✓	✓*	✓*	✓*	X
<u>D</u> iverted	<u>U</u> niverted	<u>T</u> hruflow						
								
CAP			Capped general purpose thermal gate. Typically applied on abrasive applications. Offers simplified gate detail. Three different tip styles available depending on the specific application (<i>all share a common gate detail for each nozzle series</i>)	X	X	✓	✓	✓
<u>D</u> iverted	<u>U</u> niverted	<u>T</u> hruflow						
								
HT-S6			Thermal gate for closure applications. Six hole tip to improve color change for closure applications	X	X	X	✓	X
								
TS (Thermal Sprue)			Thermal sprue gate. Typically used for Hot-to-cold applications. Will mold sprue on the part. Offers simplified gate detail. Extra Stock tip used for contouring of tip	X	✓	✓	✓	✓
Standard		Extra Stock						
								

✓	✓*	X
Standard Product	Not all specific tip styles available Contact Husky for more information	Not Available

Product Matrix *(continued)*

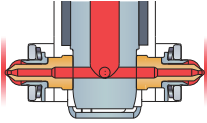
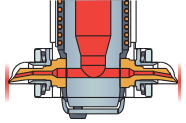
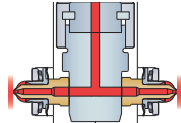
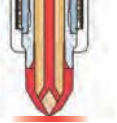
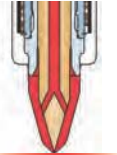
Gating Style	Application Overview	Ultra 250	Ultra 350	Ultra 500	Ultra 750	Ultra 1000
SG <i>(Ultra SideGate)</i>	 <p>Horizontal thermal gate. Small parts, gate externally on the side, generally small, long and cylindrical</p>	X	X	X	✓	X
SG Angled <i>(Ultra SideGate)</i>		 <p>Angled thermal gate. Small parts, gate externally on the side, generally small, long and cylindrical</p>	X	X	X	✓
SG Inline <i>(Ultra SideGate)</i>	 <p>Horizontal or Angled thermal gate. Small parts, gate externally on the side, generally small, long and cylindrical</p>		X	X	X	✓
UP <i>(Ultra Packaging)</i>		 <p>Packaging thermal gate. Used for high pressure, fast cycle, packaging applications.</p>	X	X	X	✓
UP-X <i>(Ultra Packaging Extended)</i>	 <p>Packaging extended thermal gate for improved gate access. Used for high pressure, fast cycle, packaging applications.</p>		X	X	X	✓

✓	X
Standard Product	Not Available

Gate Detail Dimensions

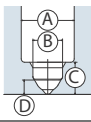
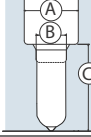
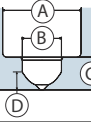
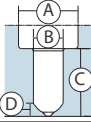
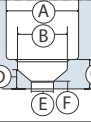
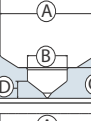
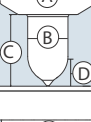
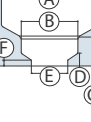
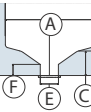
Gate Detail Dimensions (mm [in])								
Size	Tip Style	A	B	C	D	E	F	Gate Detail
Ultra 250	HT-D HT-U HT-T	12.5 [0.49"]	7.0 [0.2756"]	7.6 [0.30"]	3.4 [0.13"]	—	—	
Ultra 250	HT-DX HT-TX	12.5 [0.49"]	7.0 [0.2756"]	20.1 [.79"]	—	—	—	
Ultra 350	HT-D HT-U HT-T	16.0 [0.63"]	8.00 [0.31"]	8.3 [0.33"]	3.474 [0.137"]	—	—	
Ultra 350	HT-DX HT-UX	16.0 [0.63"]	8.00 [0.31"]	21.8 [.86"]	3.474 [0.137"]	—	—	
Ultra 350	TS	16.0 [0.63"]	11.0 [0.43"]	9.5 [0.374"]	5.71 [0.225"]	4.905 [0.19"]	3 [0.118"]	
Ultra 500	HT-D HT-U HT-T	23.8 [0.94"]	10.012 [0.394"]	7.0 [0.28"]	3.93 [0.155"]	—	—	
Ultra 500	HT-DX	23.8 [0.94"]	10.012 [0.394"]	17.0 [0.67"]	7.1 [0.28"]	—	—	
Ultra 500	CAP-D CAP-T CAP-U	23.8 [0.94"]	14.00 [0.551"]	6.40 [0.252"]	3.25 [0.128"]	9.005 [0.354"]	1.50 [0.059"]	
Ultra 500	TS	23.8 [0.94"]	—	6.67 [0.263"]	—	4.905 [0.193"]	3.00 [0.118"]	

* Flexible measurement to be confirmed with original gate detail drawing
Additional gate sizes available upon review

Gate Detail Dimensions

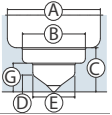
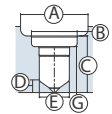
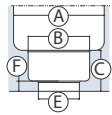
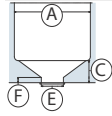
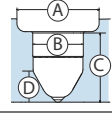
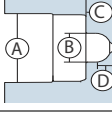
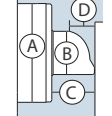
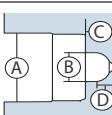
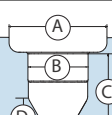
Gate Detail Dimensions (mm [in])									
Size	Tip Style	A*	B	C	D	E	F	G	Gate Detail
Ultra 750	HT-D HT-U HT-T	31.0 [1.22"]	21.0 [0.83"]	13.5 [0.531"]	5.34 [0.210"]	14.01 [0.5516"]	—	9.1 [0.358"]	
Ultra 750	HT-DX	31.0 [1.22"]	21.0 [0.83"]	25.0 [0.984"]	5.34 [0.210"]	13.80 [0.543"]	—	21.10 [0.831"]	
Ultra 750	CAP-D CAP-T CAP-U	31.0 [1.22"]	21.0 [0.83"]	13.0 [0.512"]	—	14.005 [0.5514"]	3.50 [0.138"]	—	
Ultra 750	TS	31.0 [1.22"]	—	8.5 [0.33"]	—	9.005 [0.3545"]	4.2 [0.165"]	—	
Ultra 750	HT-S6	31.0 [1.22"]	19.06 [0.7504"]	26.0 [1.02"]	11.28 [0.444"]	—	—	—	
Ultra 750	SideGate	16 [0.63"]	7 [0.27"]	6.38 [0.25"]	4.234 [0.167"]	—	—	—	
Ultra 750	SideGate (Angled)	16 [0.63"]	7 [0.27"]	8.38 [0.33"]	5.134 [0.202"]	—	—	—	
Ultra 750	SideGate (Inline)	16 [0.63"]	7 [0.27"]	6.38 [0.25"]	4.234 [0.167"]	—	—	—	
Ultra 750 UP	HT-D HT-T	31.0 [1.22"]	19.06 [0.750"]	26.0 [1.02"]	11.28 [0.444"]	—	—	—	

* Effective interfacing diameter on manifold plates is 35 mm [1.377"]

Gate Detail Dimensions

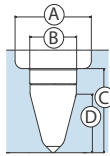
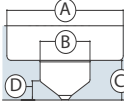
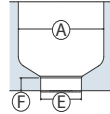
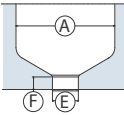
Gate Detail Dimensions								
Size	Tip Style	A*	B	C	D	E	F	Gate Detail
Ultra 750 UP	HT-DX HT-TX	31.0 [1.22"]	19.06 [0.750"]	32.8 [1.29"]	22.8 [0.9"]	—	—	
Ultra 1000	HT-D HT-T	42.0 [1.65"]	18.010 [0.709"]	13.0 [0.51"]	6.30 [0.248"]	—	—	
Ultra 1000	CAP-D CAP-T CAP-U	42.0 [1.66"]	—	—	—	20.008 [0.787"]	5.75 [0.226"]	
Ultra 1000	TS	42.0 [1.65"]	—	—	—	11.0 [0.433"]	5.25 [0.207"]	

* Effective interfacing diameter on manifold plates is 35 mm [1.377"] (Ultra 750 only)

Pitch Spacing

Nozzle Size	Guidelines	Min Pitch Layout
Ultra 250	<p>Minimum pitch dependent on melt channel size and may require the use of a tight pitch manifold bushing (Ultra 250 only)</p> <p>The sprue min radius is 31.8mm [1.25"]</p> <p>The min drop-to-drop pitch is 18 mm [0.71"]</p>	
Ultra 350		
Ultra 500	<p>The sprue min radius is 32.0 mm [1.26"]</p> <p>The min drop-to-drop pitch is 25.4mm [1.00"]</p>	

* Plunger style sprue bushing requires additional spacing. Review required

- **Pitch shown is minimum and is based on minimum melt channel sizing. Specific part, resin, and filling requirements could dictate a larger pitch spacing requirement than shown**
- Minimum distance between the outermost nozzle drop center to the outer side edge of the manifold plate is 71mm [2.79"]. (If reduced distance is required, contact Husky)
 - **For non-PRONTO systems** Application Engineering review recommended for distance less than 71mm [2.79"]
- Minimum distance between the outermost nozzle drop center to the outer top and bottom edge of the manifold plate is 96mm [3.77"]. (If reduced distance is required, contact Husky.)
 - **For non-PRONTO systems** Application Engineering review recommended for distance less than 96mm [3.77"]
- Systems greater than 16-drops layouts at minimum pitch spacing need to be reviewed by Application Engineering
- Nozzles can be grouped in maximum clusters of 8 (except for Ultra 1000)
- Tighter pitch layouts may be available, contact Husky

Pitch Spacing (continued)

Nozzle Size	Guidelines	Min Pitch Layout
Ultra 750	The sprue min radius is 40.4 mm [1.60"] The min drop-to-drop pitch is 44.5mm [1.75"]	
Ultra 750 UP		
Ultra 1000	The sprue minimum radius is 50.0 mm [1.97"] The min drop-to-drop pitch is 61mm [2.40"]	

* Plunger style sprue bushing requires additional spacing. Review required

- **Pitch shown is minimum and is based on minimum melt channel sizing. Specific part, resin, and filling requirements could dictate a larger pitch spacing requirement than shown**
- Minimum distance between the outermost nozzle drop center to the outer side edge of the manifold plate is 71mm [2.79"] (If reduced distance is required, contact Husky)
 - **For non-PRONTO systems** Application Engineering review recommended for distance less than 71mm [2.79"]
- Minimum distance between the outermost nozzle drop center to the outer top and bottom edge of the manifold plate is 96mm [3.77"]. (If reduced distance is required, contact Husky.)
 - **For non-PRONTO systems** Application Engineering review recommended for distance less than 96mm [3.77"]
- Systems greater than 16-drops layouts at minimum pitch spacing need to be reviewed by Application Engineering
- Nozzles can be grouped in maximum clusters of 8 (except for Ultra 1000)
- Tighter pitch layouts may be available, contact Husky
- **For Tip-to-Tip Spacing see Ultra SideGate section**
(If Tip-to-Tip spacing is not a constraint for pitch spacing use Ultra 750 Thermal pitch spacing for Ultra SideGate)
- **For UNIFY pitch spacing see UNIFY section**

Ultra 250 Hot Tip-Application Guidelines

Max Throughput (g/sec.)

		HT-D	HT-T	HT-U	HT-DX	HT-TX
Viscosity	Low	10	10	10	6	10
	Medium	4	4	4	2	4
	High	1	1	1	1	1

Material Compatibility

Resin	HT-D	HT-T	HT-U		HT-DX	HT-TX	Resin Structure
			Std.	WR			
ABS	✓	✓	✓	◆	◇	◇	A
LCP	◆	◆	◇	◇	◆	◆	SC
PA	◇	◆	✓	◆	◆	◆	SC
PA(33% GF)	◆	◆	◇	◇	◆	◆	SC
PBT	◆	◆	◇	◇	◆	◆	SC
PC	◇	◆	✓	◇	◇	◆	A
PE	✓	✓	✓	◆	✓	✓	SC
PET	◆	◆	◇	◇	◆	◆	SC
PETG	◆	◆	◇	◆	◆	◆	A
PMMA	◇	◆	◇	◆	◆	◆	A
PP	✓	◇	◇	◆	✓	◇	SC
PPO(PPE+PS/PA)	◆	◆	◇	◆	◆	◆	B
PS	✓	✓	✓	◆	✓	✓	A
SAN	✓	✓	✓	◆	◇	◇	A
TPE	✓	◆	✓	◆	◇	◆	A
TPUR	◇	✓	◇	◆	◇	◆	A

Application Compatibility

Resin	HT-D	HT-T	HT-U		HT-DX	HT-TX
			Std.	WR		
Abrasive	◆	◆	◆	✓	◆	◆
Color Change	✓	◇	◇	◆	◆	◆

✓ – Recommended

◇ – Requires Review

◆ – Not Recommended

SC – Semi-Crystalline

B – Blend

A – Amorphous

- Independent temperature control is required for all Ultra 250 tips (group control is not supported)
- Minimum $\Delta T = 140^{\circ}\text{C}$ [284°F] (melt to mold temperature)
- HT-DX gating not acceptable for resins with $\text{MFI} < 5$
- HT-T and HT-TX gate diameter must be $> \text{or} = 0.8\text{mm}$ [.03"]
- HT-U standard (STD) tips are not recommended if heat sensitive additives are used for very heat sensitive resins

Ultra 350 Hot Tip-Application Guidelines

Max Throughput (g/sec.)

Viscosity	HT-D	HT-T	HT-U	HT-UX	TS
	Low	15	15	15	15
Medium	8	8	8	8	8
High	3	3	3	3	3

Material Compatibility

Resin	HT-D		HT-T	HT-U	HT-DX	HT-UX	HT-URF	TS	Resin Structure
	Std.	WR							
ABS	✓	✓	◇	◇	◇	◇	◆	✓	A
Flex. PVC	◇	◇	◆	◆	◆	◆	◆	◇	A
PA	◇	◇	◆	◇	◆	◆	◆	◇	SC
PA (33% GF)	◆	◇	◆	◆	◆	◆	◆	◆	SC
PBT	◇	◇	◆	◇	◆	◆	◆	◇	SC
PBT/PC	◇	◇	◆	◇	◆	◆	◆	◇	B
PC	◇	◇	◆	◇	◆	◆	◆	◇	A
PC/ABS	◇	◇	◆	◇	◇	◇	◆	◇	B
PE	✓	✓	✓	✓	◇	◇	✓	✓	SC
PEI	◆	◇	◆	◆	◆	◆	◆	◇	A
PET	◆	◇	◆	◆	◆	◆	◆	◇	SC
PETG	◇	◇	◆	◇	◆	◆	◆	◆	A
PMMA	◇	◇	◆	◇	◆	◆	◆	◇	A
POM	◇	◇	◆	◇	◆	◆	◆	◇	SC
PP	✓	✓	◇	✓	◇	◇	✓	✓	SC
PPO (PPE+PS/PA)	◇	◇	◇	◇	◆	◆	◆	◇	A/SC
PS	✓	✓	◆	✓	✓	✓	◆	◇	A
PSU	◆	◇	◆	◆	◆	◆	◆	◇	A
SAN	✓	✓	◆	◇	◇	◇	◆	◇	A
TPE	✓	✓	◆	◇	◇	◇	◆	◇	A
TPO	✓	✓	◆	✓	◇	◇	◆	◇	A
TPUR	✓	✓	◇	◇	◇	◇	◆	◆	A

Application Compatibility

Resin	HT-D		HT-T	HT-U	HT-DX	HT-UX	HT-URF	TS
	Std.	WR						
Abrasive	◆	◇	◆	◆	◆	◆	◆	◆
Color Change	✓	✓	◇	◆	◆	◆	✓	✓

✓ – Recommended

SC – Semi-Crystalline

◇ – Requires Review

B – Blend

◆ – Not Recommended

A – Amorphous

Ultra 500 Hot Tip-Application Guidelines

Max Throughput (g/sec.)

Viscosity	HT-D	HT-T	HT-U	HT-DX	HT-TX	TS
	Low	16	16	16	16	16
Medium	10	10	10	10	10	20
High	3	3	3	3	3	12

Material Compatibility

Resin	HT-D	HT-T	HT-U	HT-DX	HT-DC	TS	Resin Structure
ABS	✓	◆	✓	✓	✓	✓	A
Flex. PVC	◇	◇	◇	◇	◇	◇	A
PA	✓	◆	✓	◇	✓	◇	SC
PA (33% GF)	✓	◆	◇	◆	✓	◇	SC
PBT	◇	◇	◇	◇	◇	◇	SC
PBT/PC	◇	◆	◇	◇	◇	◇	B
PC	◇	◆	◇	◆	◇	✓	A
PC/ABS	✓	◆	✓	◇	✓	✓	B
PE	✓	✓	✓	✓	✓	✓	SC
PEI	◇	◇	◇	◇	◇	◇	A
PETG	◆	◆	◆	◆	◇	◆	A
PMMA	◇	◆	◇	◇	✓	◇	A
POM	◇	◆	◆	◇	◇	◆	SC
PP	✓	◇	✓	✓	✓	✓	SC
PPO (PPE+PS/PA)	◇	◇	◇	◇	◇	◇	A/SC
PS	✓	◆	✓	◇	✓	◇	A
PSU	✓	◆	✓	◇	◇	◇	A
SAN	✓	◆	✓	◇	◇	◇	SC
TPE	✓	◆	✓	◇	◇	◇	A
TPO	✓	◆	✓	◇	◇	◇	SC
TPUR	◇	◆	◇	◇	◇	◆	SC

Application Compatibility

Resin	HT-D	HT-T	HT-U	HT-DX	HT-DC	TS
Abrasive	✓	◆	✓	◇	✓	✓
Color Change	✓	✓	◆	◆	✓	✓

✓ – Recommended

SC – Semi-Crystalline

◇ – Requires Review

B – Blend

◆ – Not Recommended

A – Amorphous

Ultra 750 Hot Tip-Application Guidelines

Max Throughput (g/sec.)

Viscosity	HT-D	HT-T	HT-U	HT-DX	HT-DC	TS	HT-S6
	Low	175	175	175	175	175	350
Medium	80	80	80	80	80	250	80
High	40	40	40	40	40	60	40

Material Compatibility

Resin	HT-D		HT-T		HT-U		HT-DX		HT-DC		TS	HT-S6	Resin Structure
	STD	WR	STD	WR	STD	WR	STD	WR	STD	WR			
ABS	✓	✓	✓	✓	✓	✓	✓	✓	✓	✓	✓	◆	A
CAB	◇	◇	◆	◆	◆	◆	◆	◆	◇	◇	◇	◆	A
Flex. PVC	◇	◇	◆	◆	◆	◆	◆	◆	◆	◆	◇	◆	A
PA	✓	✓	✓	✓	◇	◇	◆	◆	✓	✓	✓	◆	SC
PBT	◇	◇	◆	◆	◆	◆	◆	◆	◇	◇	✓	◆	SC
PBT/PC	✓	✓	◆	◆	◆	◆	◆	◆	◇	◇	◇	◆	SC
PC	✓	✓	◆	◆	◆	◆	◆	◆	✓	✓	✓	◆	A
PC/ABS	✓	✓	✓	✓	◇	◇	◆	◆	✓	✓	✓	◆	
PE	✓	✓	✓	✓	✓	✓	✓	✓	✓	✓	◇	◇	SC
PEI	◇	◇	◆	◆	◆	◆	◆	◆	◇	◇	◇	◆	A
PETG	◆	◆	◆	◆	◆	◆	◆	◆	◇	◇	◇	◆	A
PMMA	✓	✓	◇	◇	✓	✓	✓	✓	✓	✓	✓	◆	A
POM	✓	✓	✓	✓	◆	◆	◆	◆	◇	◇	◇	◆	SC
PP	✓	✓	◇	◇	✓	✓	◇	◇	✓	✓	✓	✓	
PPO	✓	✓	◆	◆	◆	◆	◆	◆	✓	✓	✓	◆	A/SC
PPS	◇	◇	◆	◆	◆	◆	◆	◆	◇	◇	◇	◆	SC
PS	✓	✓	✓	✓	✓	✓	✓	✓	✓	✓	◇	◇	A
PSU	◇	◇	◆	◆	◆	◆	◆	◆	◇	◇	◇	◆	A
SAN	✓	✓	✓	✓	◆	◆	◆	◆	✓	✓	◇	◆	A
TPE	✓	✓	✓	✓	✓	✓	✓	✓	✓	✓	◇	◆	A
TPO	✓	✓	✓	✓	◆	◆	◆	◆	✓	✓	◇	◆	A
TPUR	✓	✓	◇	◇	◆	◆	◆	◆	✓	✓	◆	◆	A

Application Compatibility

Resin	HT-D		HT-T		HT-U		HT-DX		HT-DC		TS	HT-S6
	STD	WR	STD	WR	STD	WR	STD	WR	STD	WR		
Abrasive	◆	✓	◆	✓	◆	✓	◆	✓	◆	✓	✓	◆
Bev Closure	◇	◇	◇	◇	◇	◇	◇	◇	◇	◇	◇	✓
Color Change	✓	✓	◇	◇	◆	◆	◆	◆	✓	✓	✓	✓

✓ – Recommended

SC – Semi-Crystalline

◇ – Requires Review

B – Blend

◆ – Not Recommended

A – Amorphous

Ultra 750 UP-Application Guidelines

Max Throughput (g/sec.)

		UP HT-D	UP HT-T	UP HT-DX	UP HT-TX
Viscosity	Low	300	300	300	300
	Medium	-	-	-	-
	High	-	-	-	-

Material Compatibility

Resin	UP HT-D	UP HT-T	UP HT-DX	UP HT-TX	Resin Structure
PE	◇	✓	◇	✓	SC
PP	✓	◇	✓	◇	SC
PS	✓	◇	✓	◇	A

✓ – Recommended

SC – Semi-Crystalline

◇ – Requires Review

B – Blend

◇ – Not Recommended

A – Amorphous

- High speed, high pressure packaging nozzle
- Uses 750 Series gate detail

Ultra 1000 Hot Tip-Application Guidelines

Max Throughput (g/sec.)

	HT-D	HT-T	HT-DC	TS	
Viscosity	Low	350	350	350	750
	Medium	150	150	150	350
	High	50	50	50	90

Material Compatibility

Resin	HT-D	HT-T	HT-DC	TS	Resin Structure
ABS	✓	◆	✓	◇	A
PA	✓	◆	✓	✓	SC
PA(GF)	◇	◇	✓	✓	SC
PBT	◇	◇	◇	✓	SC
PBT/PC	◇	◆	✓	✓	B
PC	◇	◆	◇	✓	A
PC/ABS	◇	◆	✓	✓	B
PE	✓	✓	◇	✓	SC
PETG	◆	◇	◇	◆	A
PMMA	◇	◆	◇	✓	A
POM	◇	◆	◇	◇	SC
PP	✓	◇	✓	✓	SC
PP (TALC)	✓	◇	◇	◇	SC
PPO(PPE+PS/PA)	✓	◇	◇	◇	A/SC
PS	✓	◆	✓	✓	A
SAN	✓	◆	✓	◇	A
TPE/TPO	◇	◇	◇	◆	A

Application Compatibility

Resin	HT-D	HT-T	HT-DC	TS
Abrasive	◇	◇	✓	✓
Color Change	◆	◆	✓	✓

✓ – Recommended

SC – Semi-Crystalline

◇ – Requires Review

B – Blend

◆ – Not Recommended

A – Amorphous

Single Drops-Hot Sprue

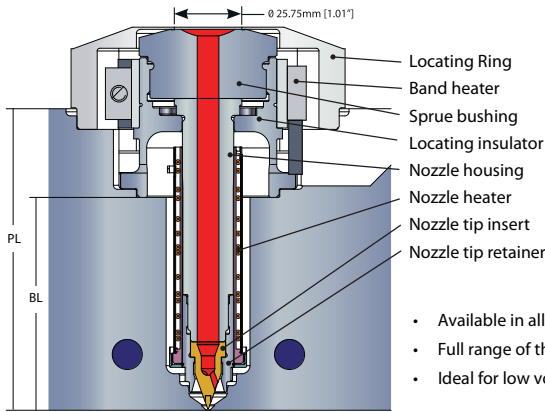

- Available in all sizes
- Full range of thermal gating options
- Ideal for low volume or prototype purposes

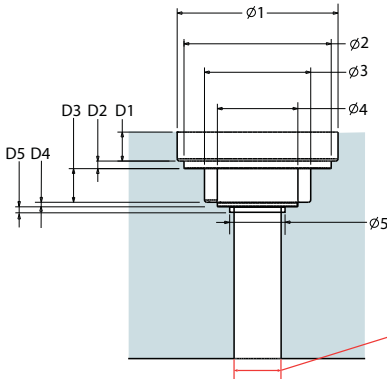

- Installs direct into platen side of the 'A' side plates
- Relief bore depth "D1" may vary to accommodate standard nozzle housings

***This dimension is dependent on the size of the nozzle
* Please note there is a longer lead time for XL dimensions***

Nozzle size	01	02	03	04	05	D1 Max	D2	D3	D4	D5	Min PL	Max PL	Max XL* PL	Min BL	Max BL	Max XL* BL	
Ultra 250	Locating Ring Relief (Dependent on Locating Ring dia. Selected)	97.01mm [3.819"]	63mm [2.48"]	34.12mm [1.343"]	-	16.8mm [0.661"]	5mm [0.197"]	15.1mm [0.594"]	3mm [0.118"]	-	87mm [3.42"]	203mm [7.99"]	N/A	64mm [2.51"]	160mm [6.29"]	N/A	
Ultra 350		97.01mm [3.819"]	63mm [2.48"]	40.52mm [1.595"]	-			15.1mm [0.594"]			58mm [2.28"]	214mm [8.42"]	N/A	34mm [1.33"]	170mm [6.69"]	N/A	
Ultra 500		97.01mm [3.819"]	63mm [2.48"]	40.52mm [1.595"]	27mm [1.063"]			15.1mm [0.594"]			2.5mm [0.093"]	55mm [2.16"]	170mm [6.69"]	300mm [11.81"]	31mm [1.22"]	130mm [5.11"]	270mm [10.62"]
Ultra 750		97.01mm [3.819"]	70mm [2.756"]	53.02mm [2.087"]	-			22.15mm [0.872"]			69mm [2.71"]	185mm [7.28"]	320mm [12.59"]	39mm [1.53"]	138mm [5.43"]	275mm [10.82"]	
Ultra 1000		97.01mm [3.819"]	70mm [2.756"]	58.02 [2.284"]	-			17.93mm [0.706"]			97mm [3.81"]	233mm [9.17"]	N/A	71mm [2.79"]	190mm [7.48"]	N/A	

Single Drops-Hot Sprue

Configure to Order (CTO) vs Engineering to Order (ETO)

CTO:

- Shorter lead time
- 2D installation drawings available on-line prior to order
- 3D model, gate details and BOM available within 24hrs of order and complete information for project
- More competitive price
- Only standard components

ETO:

- Custom nozzle lengths available
- Can support more demanding applications such as corrosive resins
- Standard and custom components

CTO Offerings

Product	Nozzle Series	Sprue Inlet Diameter	Gating Style	Nozzle Housing Length [mm]
Hot Sprue	U350	4*, 6.35	HT, TS	55,65...185,195
	U500	4*, 6.35, 8	HT, TS, CAP	50,60...190,200
	U750	4*, 11.5	HT, TS, CAP	50,60...190,200
	750	4*, 11.5	HT-S6	50,60...190,200
	U1000	6.5*, 11.5	HT, TS, CAP	70,90...170,190

* Only available with flat radius

- Please refer to on-line drawings for BL and PL values
<https://milexternal.husky.ca/login/login.asp?x=1&pid=293>
- Sprue seal off type (mm): flat, 12.7, 15.5, 19.05, 20, 40
- Locating ring (mm): 100, 101.3 (3,99"), 125
- Standard electrical connectors and electrical box adapter available as paid options

Energy Savings Package (ESP) for Closures Hot Runners

Selling Value

- Specifically designed for the closure market (MW, CSD, beverage closures in general, overcaps usually molded with the HT-S6 nozzle)
- Help to reduce heat loss from largest sources of the hot runner resulting in energy savings
- Similar performance
- No cost increase
- Key dimensional differences:
 - Nozzle bore relief increased to 37mm [1.45"] (Std 31mm[1.22"]) to have full benefit of energy savings
 - Nozzle pitch increase to 50mm [1.96"] (Std 44.5mm [1.75"])
 - HR shut height increase by up to 16mm [0.62"]
 - L-dim:
 - Up to 60mm [2.36"] (nozzle housing length 120mm [4.72"] max).
 - Preferred value: L-dim 30mm or 40mm (nozzle housing length 90mm [3.54"] and 100mm [3.93"] respectively)

Benefits

- Up to 30% energy savings over standard hot tip (HT-S6) applications
- Minimal impact on mold design (check possibility to increase heater bore relief to 37mm [1.45"] in the gate insert)
- Similar processing window
- Similar heat up time
- Similar color change performance as standard

Features

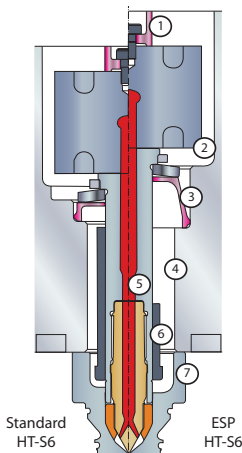

1. 14 mm [0.55"] height back-up pad 10mm [0.39"] std
2. 7 mm [0.27"] bottom manifold clearance 5mm [0.19"] std
3. Low conduction nozzle insulator 10mm [0.39"] longer housing typically required
4. Larger nozzle bore (37mm [1.45"]) Ø31mm [1.22"] std
5. Modified nozzle housing
6. Short UNH heater (30mm [1.18"]) 70mm [2.75"] std
7. Increase clearance on gate insert

Ultra 750 Ultra Packaging Nozzle (UP)

Ideal for High Speed Packaging Applications

- Cycle times as low as 3 seconds
- Up to 2413 bar [35k psi] injection pressure
- Throughputs up to 300 g/sec.
- TC or % control

Features

- Robust design
 - Seal-off land = 2mm [0.78"]
 - Seal-off \varnothing = 19.05mm [0.75"]
 - Nozzle housing \varnothing = 22.3mm [0.875"]
- Matches 750 Series gate detail
- Easy maintenance
 - Easy tip removal / replacement
 - Tips and retainers replaceable without removing nozzle heater
- Gating options
 - Diverted
 - Extended Diverted
 - Throughflow
 - Extended Throughflow

For a description of the criteria that defines a part as "Thinwall" please contact Huskys



In this section:

Page

6-1Overview

6-5Ultra SideGate-Application Guidelines

6-6 Ultra SideGate Angled

6-6Ultra SideGate Inline

6-7Specials

Overview

Typical target applications and typical markets

- Parts which are small, long, open ended at both ends
- Typical part size range: 0.2 to 10.0 grams (depending viscosity and injection time)
- When core pins restrict access for conventional gating
- For cold runner elimination
- Medical market: pipette tips, syringe barrels, infusion-transfusion components tube connectors, luer, luer lock
- Closure market: specialty closures, flip top caps
- Technical market: small technical components (check resin compatibility)

Flexibility and Part Quality

- Flexibility: 1, 2 or 4 tips per nozzle
- Design flexibility in the cooling placement (possible around long parts)
- No split cavity required, no witness line
- Gate quality: Typically $< 0.05\text{mm}$
- Resin dependant, stiffer the resin, the better (Consult Application Engineering for critical gate quality application)

Ultra SideGate Order Guidelines

- See Material Compatibility & Throughput per gate chart
- Gate diameter - 0.70mm [0.027"], 0.80mm [0.031"], and 0.90mm [0.034"] based on application
- Gate diameter - 0.60mm [0.023"], for gate diameter available, based on application and gate diameter guidelines
- Standard pitch spacing (tip-to-tip): 55mm [2.16"], others see specials section
- Gate cooling: mandatory review of cooling design by Application Engineering
- Additional mold maker information available from Husky



Overview

Principle

- Tip independent from the nozzle housing; always aligned with the gate
- Simple integration without cavity split and easy gate detail manufacturing
- Tip sealing obtained with a spring load

- Better part quality (no witness line from cavity split)
- Less scrap
- Less mold maintenance cost
- Lower cavity insert cost
- Small footprint – more cavities in smaller mold size
- 1, 2 or 4 cavity per nozzle

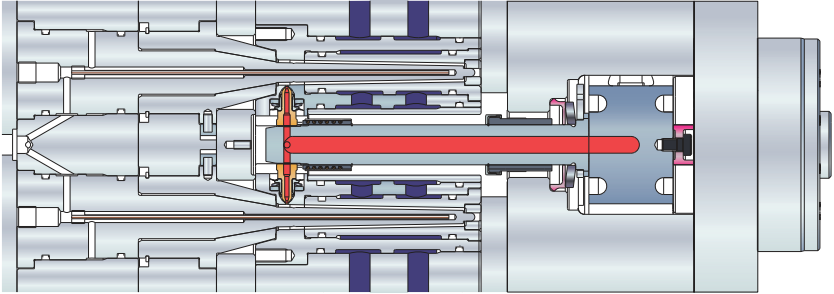

Tip assembly, features and benefits

1. Ceramic insulation – wide process window
2. Low conduction seal ring – wide process window
3. High conduction tip body – wide process window
4. Anti-tilting fingers – ensures leak-proof operation
5. Wear resistant ring – preserve seal surface
6. Spring seal – prevent plastic leak – cold start protection

- No special start up procedure required (no temperature boost)
- No need for special controller
- Reduce risk of cavity loss or short shot
- Spring seal prevent accidental plastic leak
- Seal longevity prevent plastic leakage and avoid downtime

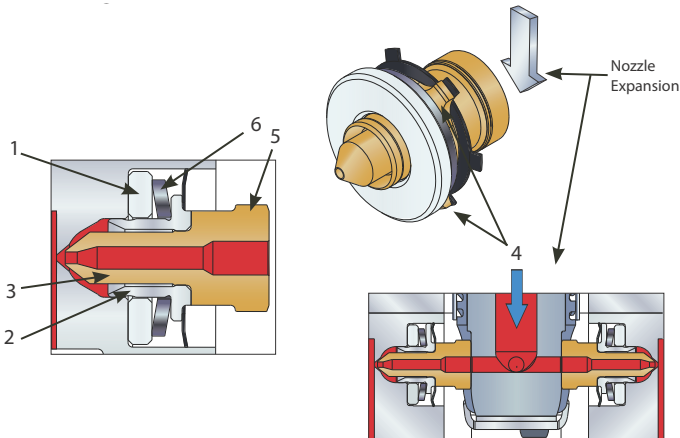

Overview

Maintenance

- Easy maintenance from the split line into the press
- Full benefit of the ease of maintenance when tool design allow to pull gate insert from the split line
- Blank tip available to neutralize cavities individually



- Gate contamination cleaning in less than 30 minutes from stop to start
- Tip, TC, heater change from split line
- Faster and easier than most competitors

Gate quality

- Direct thermal gating
- Gate sheared off during mold opening



- Direct gating on geometries typically gated by cold runner
- Eliminate cold runner
- Commodity and technical resins
- Excellent gate quality

Balance

- Typical balance performance 75% to 95% depending on resin, part weight
- Improved balance tip for PP: up to 95% @ 90% short shot including random block copolymer PP
- Consult Application Engineering or product manager for details

Tip-to-Tip Pitch Spacing

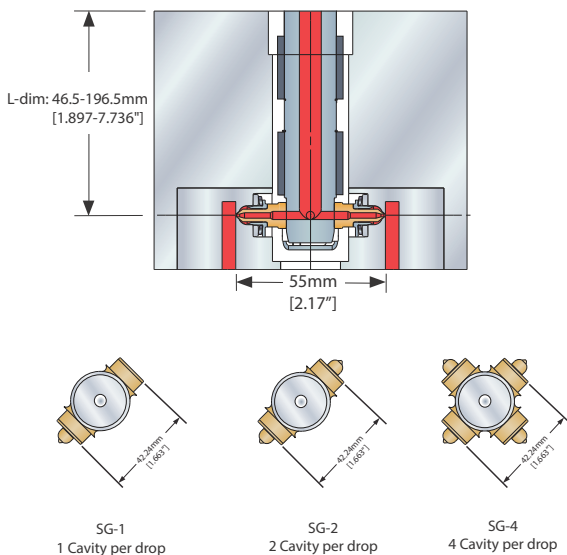

Overview

Gate Detail Consideration

- Minimum steel thickness

Correct

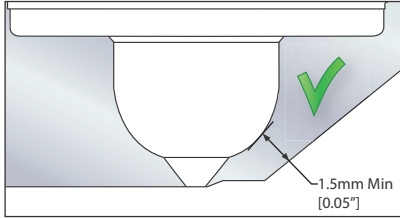

Incorrect

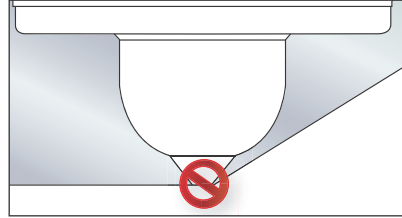

- Gate location on the part

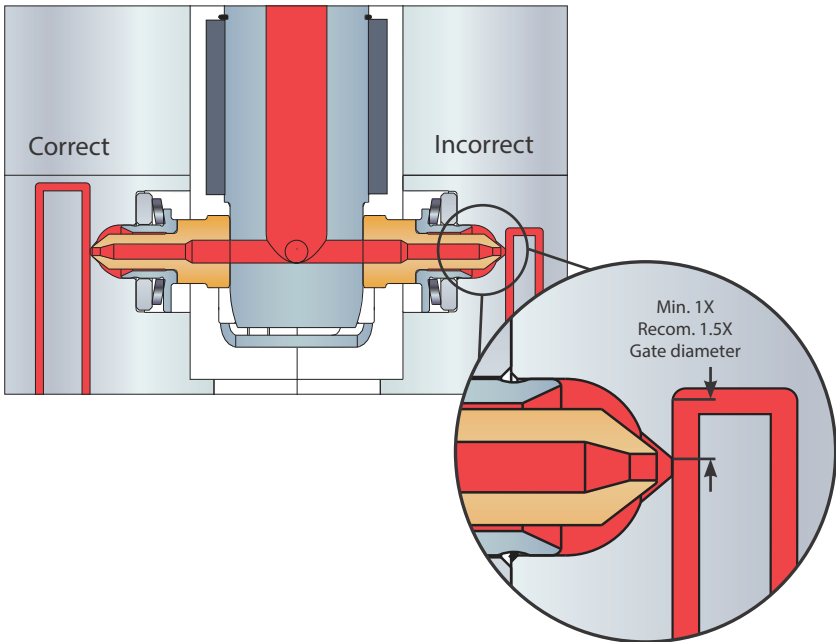

Ultra SideGate-Application Guidelines

Max Throughput per gate (g/sec.)

	SG-1	SG-2	SG-4	
Viscosity	Low	10	10	10
	Medium	4	4	4
	High	1	1	1

Material Compatibility

Resin	SG HT-T	SG HT-U	SG HT-URF	Resin Structure
ABS	✓	◇	◆	A
COC	✓	◇	◆	A
COP	✓	◇	◆	A
Flex. PVC	◆	◆	◆	A
MABS	✓	◇	◆	A
PA	◇	◇	◆	SC
PBT	◇	◇	◆	SC
PBT/PC	◆	◆	◆	B
PC	✓	◇	◆	A
PC/ABS	◇	◇	◆	B
PCTG, PCTA	✓	◇	◆	A
PE	✓	◇	◆	SC
PEI	◆	◆	◆	A
PET	◆	◆	◆	SC
PETG	◆	◆	◆	A
PMMA	✓	✓	◆	A
POM	◆	✓	◆	SC
PP	◇	✓	✓	SC
PPO	◆	◆	◆	A/SC
PPS	◆	◆	◆	SC
PS	✓	◇	◆	A
PSU	◆	◆	◆	A
SAN	✓	◇	◆	A
SBC (K-Resin)	✓	◇	◆	A
TPE	◆	◇*	◆	A
TPO	◆	◇*	◆	A
TPUR	◆	◇*	◆	A

Application Compatibility

Resin	SG HT-T	SG HT-U	SG HT-URF
Abrasive	◆	◆	◆
Color Change	◇	◇	✓

✓ – Recommended

SC – Semi-Crystalline

◇ – Requires Review

B – Blend

◆ – Not Recommended

A – Amorphous

- All gate cooling layouts must be reviewed by Husky prior to machining
- In case of color change, HT-U should be preferred when resin is compatible

*-Good process window but creating high vestige – consult Application Engineering

Ultra SideGate Angled

Angled tip:

- Improve access on part closer to the parting line
- Reduce the offset of the split line
- Consult Application Engineering or product manager for details

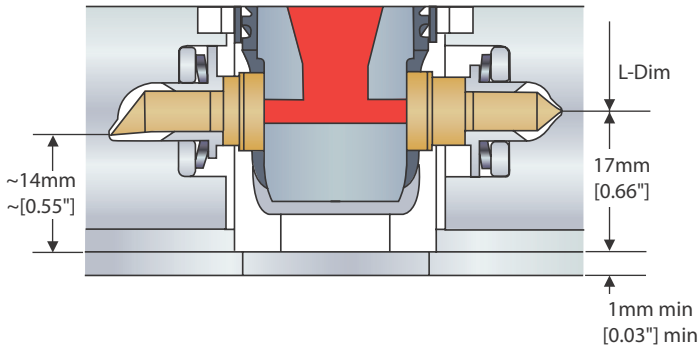

Ultra SideGate Inline

Inline Configuration:

- Smaller mold base with tight part spacing
- Split cavities not required for hot runner integration
- Consult Application Engineering or product manager for details

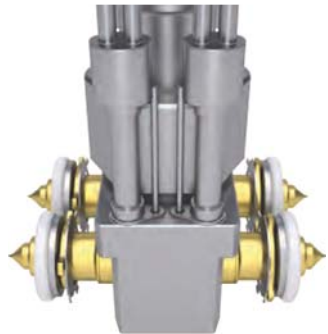
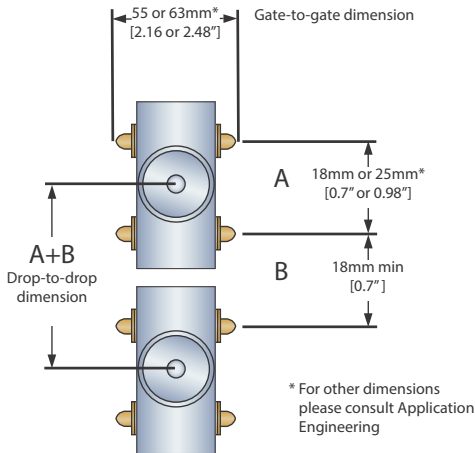

Specials

- Custom tip length (CAUTION, standard 55mm [2.16"] should always be preferred)
 - Gate to gate distance from 55mm [2.16"] to 63mm [2.48"] continuously
 - Additional charge for tip length longer than 55mm [2.16"]
 - Blank in place for gate distance from 55mm to 63mm (2 weeks lead time)
 - HT-T and HT-U
 - Resins: Polyolefins, Styrenics, others on review
 - May require adjustment of nozzle tip temperature set point and possible impact on short shot balance

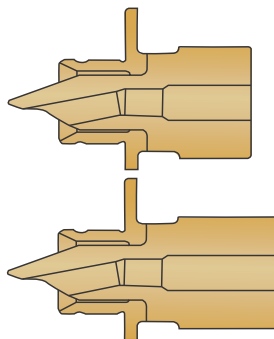
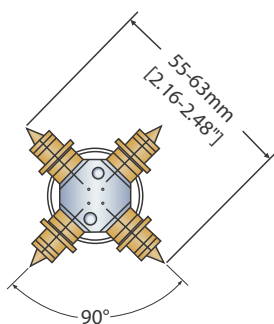

- Husky application review required for all SG specials
- Tighter nozzle pitch
 - Smaller than 44.5mm [1.75"] standard value
 - If cavity size allows for it
 - Minimum 35mm [1.37"] with non-standard nozzle spring pack and nozzle housing
 - Resins: Polyolefins, Styrenics, others on review

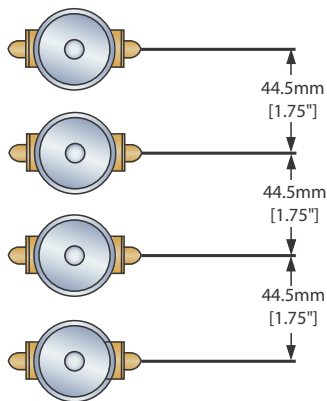

Standard nozzle pitch
(min. value shown)

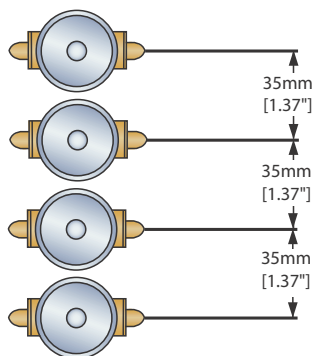

Special tight nozzle pitch
(min. value shown)

Specials

- Special layouts
 - Requires non-standard nozzle housings (other configuration than SG1, SG2 @ 180° or SG4)
 - Example shows SG2 @ 90°, in a square configuration
 - Like for SG1, opposite side of the tips to be supported with a dummy spacer – to be considered for the mold construction
 - ARF MANDATORY – longer lead time

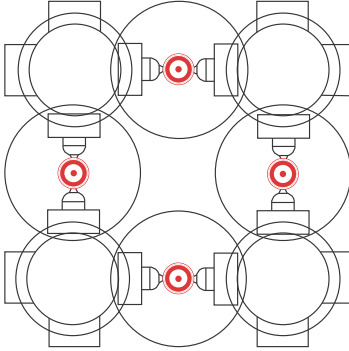

Square configuration - to minimize core shifting in critical applications (If core shifting cannot be addressed with part / mold design)

In this section:

Page

7-1 PRONTO Overview

7-2Design for PRONTO

7-9 PRONTO – FAQ

PRONTO Overview

Benefits

Faster Delivery*

Take advantage of reduced lead time when ordering PRONTO products.

Easy to Order

Follow the PRONTO guidelines noted in this handbook.

No Compromise in Quality

- Optimized melt channels
 - Leak proof warranty

Lower Price*

Take advantage of reduced price for all PRONTO products.

Featuring

Optimized Processing

- Ultra 250, 350, 500, 750, 1000 as well as Ultra Helix 250, 350, 500, 750
- Melt channels customized for each application

Flexible Pitch

- 1-32 drop manifold and hot runner systems (1-4 drops for Ultra 1000)
- 17 different manifold layouts
- Even profile for every application
- Balanced manifold layouts with level changes and thermally validated heater design ensure optimized processing for all applications

Configurable plates

- Flexible plate size
- Customer specified guide pin and interface taps
- Multiple clamping options including DME and oversized backing plate

Multi Material (2K)

- Single face
- Independent injection (no co-injection) from injection side only (no side/top injection)
- Max 32 drop hot runner or manifold system (16 + 16)
- U1000 not available

*Applications requiring custom components will not be given PRONTO lead time or price



Design for PRONTO

5 step process for PRONTO eligibility

1. Nozzle Length
2. Sprue Clearance
3. Pitch spacing
4. Plate Sizes
5. Configurable system options

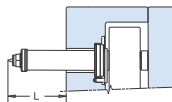

Nozzle	Gate	Min-L	Max-L	Ext-L*
U250 / Ultra Helix 250	VG HT	13 [0.51"]	150 [5.90"]	-
U350 / Ultra Helix 350	VG HT	17 [0.67"]	170 [6.69"]	-
U500 / Ultra Helix 500	VG HT	14 [0.55"] 20 [0.79"]	230 [9.06"]	290 [11.41"]
U750 / Ultra Helix 750	VG HT	27.4 [1.08"]	180 [7.08"] 230 [9.06"]	290 [11.41"]
U1000	VG HT	28 [1.10"] 29.3 [1.15"]	250 [9.84"] 300 [11.81"]	300 [11.81"] -

Step 1—Nozzle Length

- Must fall within range of min/max
- Any increment within range
 - Same for VG/HT

* Longer lead time may apply

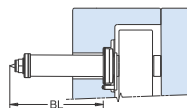

Nozzle	Gate	Min-BL	Max-BL	Ext-BL*
U250 / Ultra Helix 250	VG HT	79 [2.75"]	165 [6.49"]	-
U350 / Ultra Helix 350	VG HT	53 [2.08"]	185 [7.28"]	-
U500 / Ultra Helix 500	VG HT	70 [2.75"] 85 [3.34"]	245 [9.65"]	305 [12"]
U750 / Ultra Helix 750	VG HT	57 [2.24"] 64 [2.51"]	195 [7.68"] 245 [9.65"]	305 [12"]
U1000	VG HT	82 [3.22"]	270 [10.63"] 320 [12.59"]	320 [12.59"] -

Step 2—Sprue Clearance

- Minimum distance from inner drop to sprue (Min Drop)
- Allows for standard design/components
- Maximum manifold size (Max Drop)
 - Distance from outer most drop to sprue

** Air Plate out of scope for U1000 PRONTO

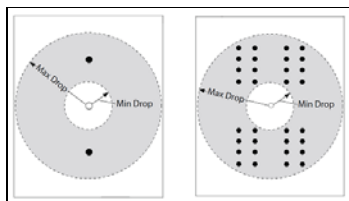

Gate	Nozzle	Min Drop	Max Drop
Hot Tip	U250	31.8 [1.25"]	300 [11.8"]
	U350		
	U500	32 [1.26"]	500 [19.7"]
	U750	40.4 [1.59"]	
	U1000	50 [1.97"]	
Valve Gate	U250 and UH250	SX - 45 [1.77"]	300 [11.8"]
	U350 and UH350	SX - 45 [1.77"]	300 [11.8"]
		LX - 50 [1.96"]	
	U500 and UH500	SX - 45 [1.77"]	300 [11.8"]
		LX - 50 [1.96"] EX - 65 [2.55"]	
	U750 and UH750	LX - 50 [1.96"]	400 [15.7"]
EX - 65 [2.55"]			
U1000	72 [2.83"]	500 [19.7"]	

Design for PRONTO

Step 3—Pitch Spacing

- Same spacing requirements as our custom systems
- Dependent on nozzle size and gating style
 - Allows for standard design/ components

 = Ultra 1000 PRONTO only available in these layouts and only available up-to 4-drops

Gate	Nozzle	Min Pitch
Hot Tip	U250	18 [0.71"]
	U350	18 [0.71"]
	U500	25.4 [1.00"]
	U750	44.5 [1.75"]
	U1000	61 [2.40"]
Valve Gate	U250 and UH250	SX - 25.4 [1.00"]
	U350 and UH350	LX - 50 [1.96"]
	U500 and UH500	SX - 25.4 [1.00"]
		LX - 50 [1.96"]
	U750 and UH750	EX - 59 [2.33"]
		LX - 50 [1.96"]
U1000	EX - 59 [2.33"]	
	75 [2.95"]	

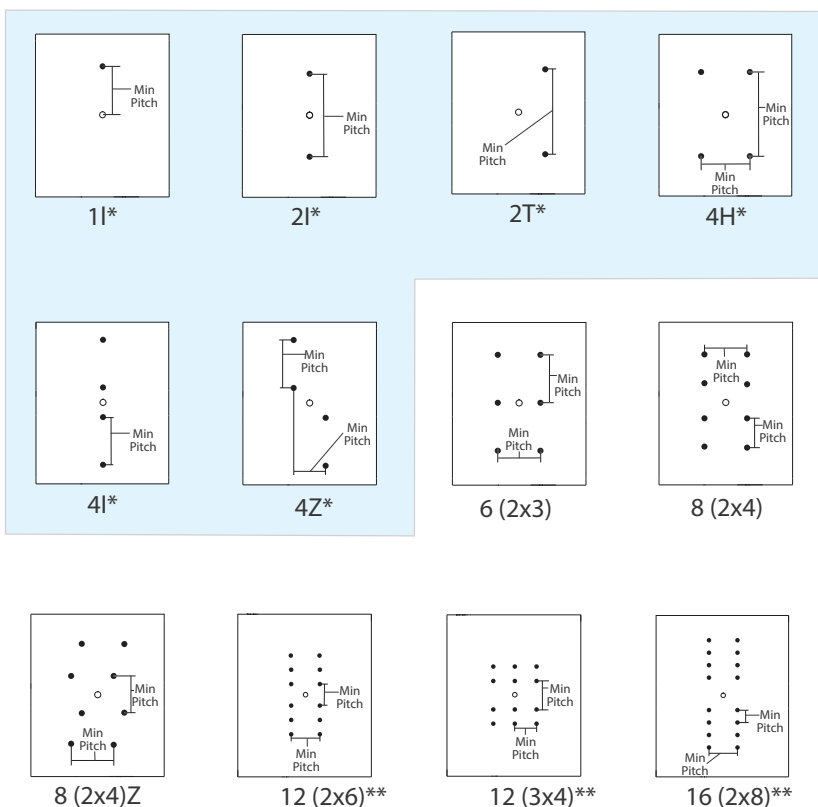

** For systems 12 -drops and above pitch spacings (vertical and horizontal) must be equal. [Spacing across the sprue (0,0) may vary] i.e. as shown

Design for PRONTO

Step 3—Pitch Spacing (Continued)

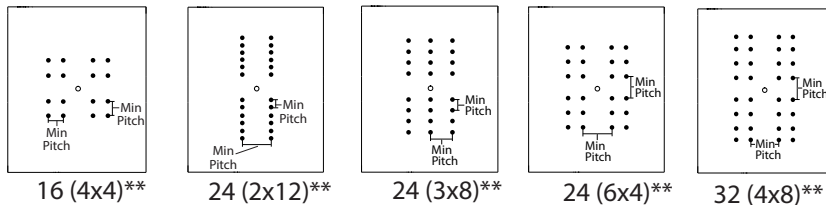

** For systems 12–drops and above pitch spacings (vertical and horizontal) must be equal. [Spacing across the sprue (0,0) may vary] i.e. as shown

* Pitch Flexibility

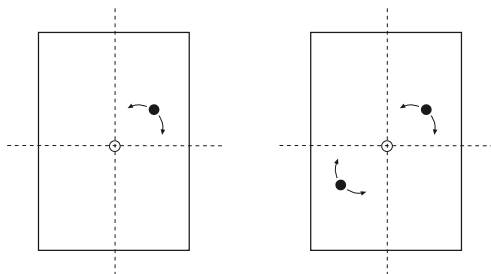

Pitch locations for 1 and 2 drop PRONTO systems are fully flexible and can be rotated about the injection point.

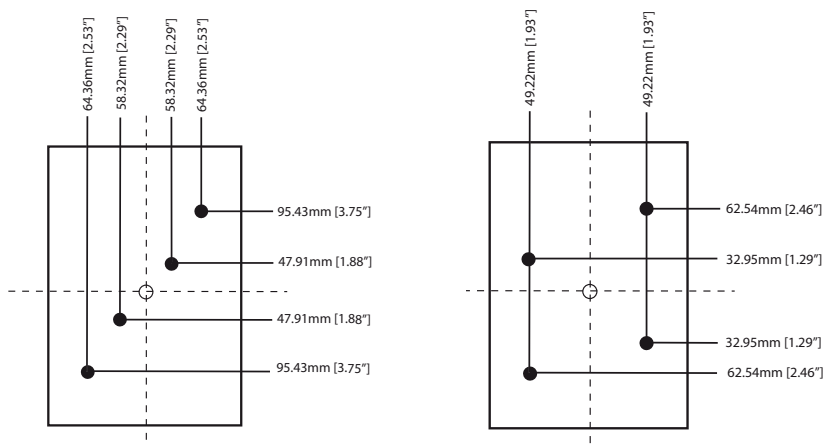

Pitch location for 4 Drop PRONTO systems is available in both symmetrical and asymmetrical configurations. Asymmetrical layouts still require injection to be located at the center of the mold. As seen in the example, drop locations must feature the same dimensions in two different quadrants. For example the inner drops are both located at (58.32, 47.91) and the outer drops are both located at (64.36, 95.43)

Design for PRONTO

Step 3—Pitch Spacing (Continued)

** For systems 12 -drops and above pitch spacings (vertical and horizontal) must be equal. [Spacing across the sprue (0,0) may vary] i.e. as shown

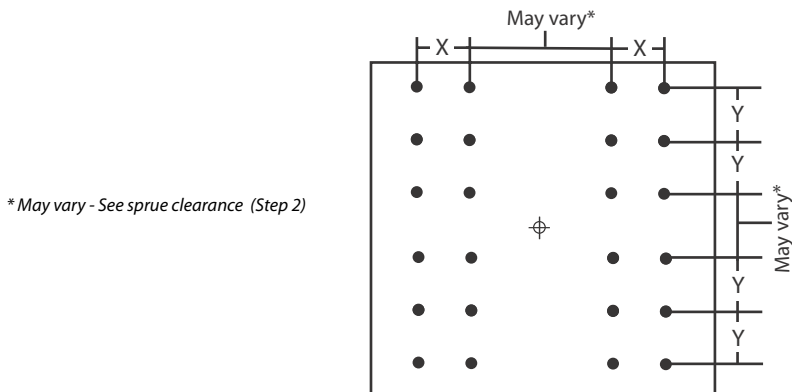

Step 4—Plate Sizing

- Confirm plate sizes are within the maximum available width and height
- Check that all drop locations fit within the "area available for drops"

(leaving adequate open space at the edge of the plates)

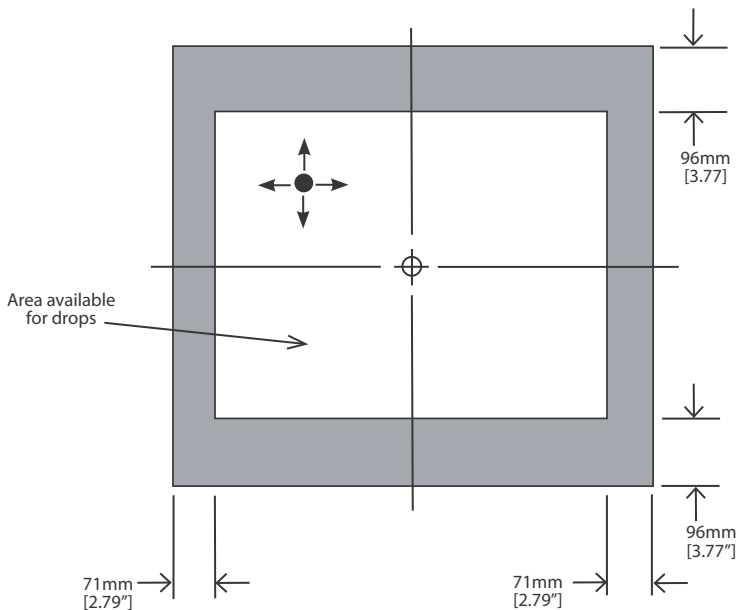

Maximum Plate Width : 1200mm [47.3"]

Maximum Plate Height : 1500mm [61.0"]

Design for PRONTO

Step 5—Configurable Options

- Clamping Options
 - Benefits
 - Easy specification
 - Predictable design
 - Features
 - Industry standard clamping
 - Choice of clamping thickness

- Electrical Options
 - Requirements
 - Top Locations
 - Choose from standard connector offering

- Guide Pins and Interface Options
 - Guide Pins
 - DME/Hasco
 - Any size, location, qty
 - Interface Options
 - Metric/Imperial
 - Any size, location, qty

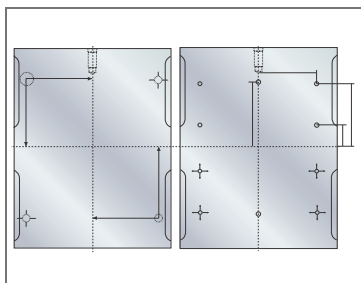
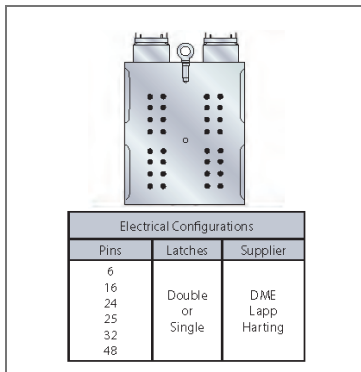
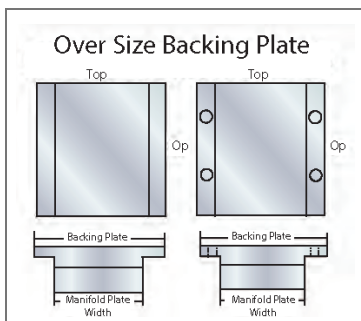
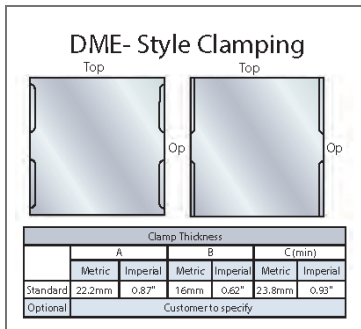

Design for PRONTO

Step 5—Configurable Options *(Continued)*

- Utility Locations
 - Water
 - Air

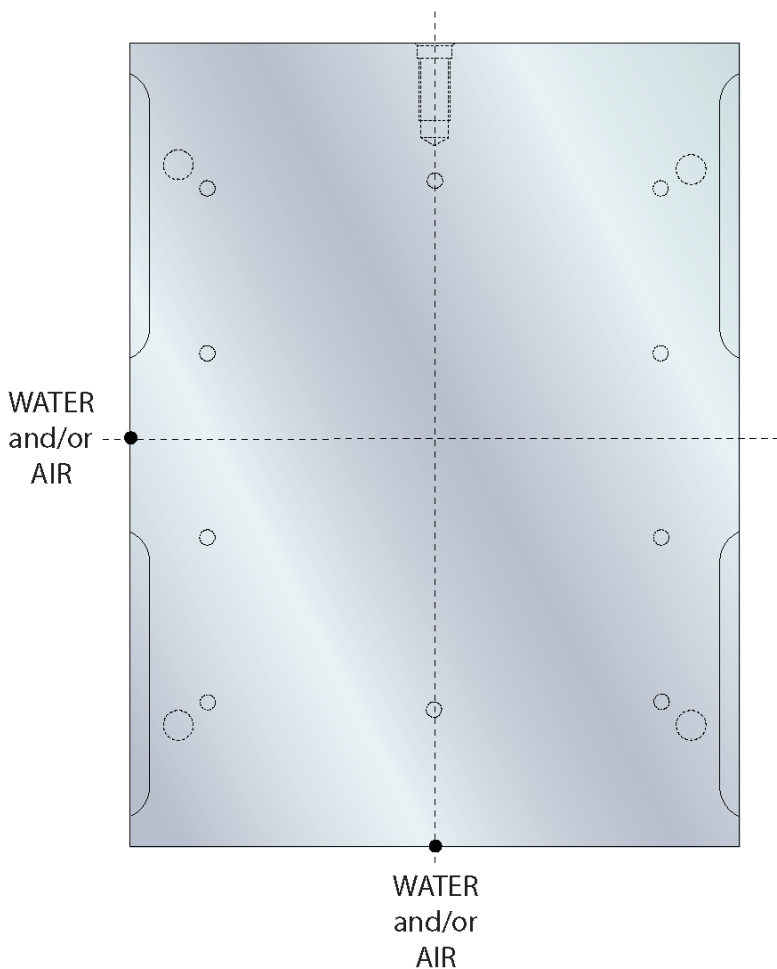

Available Fittings					
	DME	Festo	Hasco	Parker	Staubli
Air	✓	✓	✓	✓	✓
Water	✓		✓	✓	✓

Design for PRONTO

Step 5—Configurable Options-Custom Cutouts

- Installations:
 - Back-up cutouts
 - Latch cutouts
 - Cutouts for bolting
- Requirements:
 - Manufacturing tolerance +/- 0.2 mm

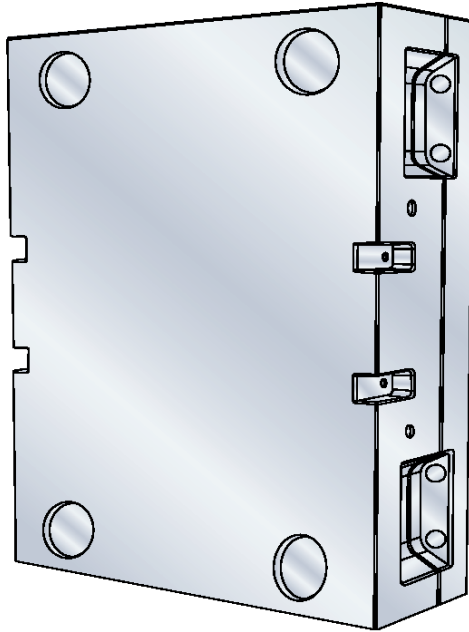

PRONTO – FAQ

Q: What items are allowable in PRONTO systems:

- A:
 - Customized plate cutouts with manufacturing tolerances ± 0.2 mm
 - If drop to plate edge is at the min, cut-outs should be reviewed by Project Engineering; plate thickness might be increased by depth of cutouts
 - There are no limits in number of cut-outs, but there should be enough space for wire grooves. If cut-outs are not in the corners, it should be reviewed by Project Engineering
 - Sequential Valve Gate limited to 4 drop Hot Runner systems
 - Must be reviewed by Husky Project Engineering, additional circuits and limited space would be a constraint to install other standard features
 - Customized items like locating ring or sprue bushing (at an additional cost and lead time, check with Husky factory)
 - Corrosive/high pressure/high temp application (at an additional cost and increased lead time)
 - Different nozzle length are allowable for PRONTO. Moldflow may be required with 2 different L-dims
 - Powertech Box installation



PRONTO – FAQ

Q: Which items do not fit within PRONTO?

A: The following items do not fit into PRONTO but may be available through our custom systems:

- Special shut-off geometry (angle, diameter, tolerances)
- Contoured gate (HT or VG)
- Special gate insert design or gate manufacturing request from customer except Ultra Helix
- Interface taps from backing plate to customer mold, because it leads to customized design of hot runner
- Offset injection location, because it might lead to unbalanced system and custom design
- Reverse taper stem, customized manifold bushings
- Customer circuits in Hot Runner plates
- Thru-holes
- Modified gate land, gate bubble or customized nozzle tip are allowable after review by application engineering and part number should be provided with project specification

If your application requires any of these items please contact Husky to inquire about our custom hot runner

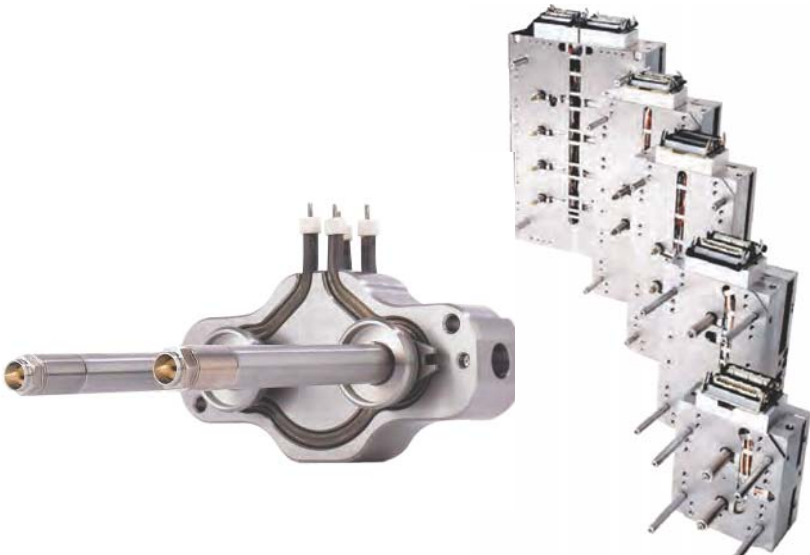

In this section:

Page

8-1	Overview
8-2	Thermal Gate Consideration
8-3	Valve Gate Consideration
8-4	Sprue Bar
8-5	Standard Sprue Bar Installations
8-6	Standard Sprue Bar Pressure Limits
8-7	Offset Sprue Bar
8-8	Split Sprue Bar

Overview

Husky offers 2 level stack manifold systems and hot runners. A 2 level stack mold will nearly double the output per machine of a single face mold. Husky's experience gained in building over 3000 stack hot runners assures that all aspects of integrating the hot runner into the mold will be taken into account during design.

- In addition to 2 level stack systems; Husky has successfully built many 3 level and 4 level systems

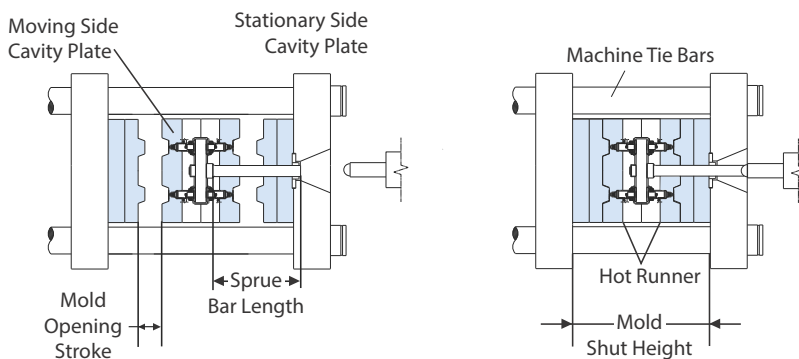

Standard Sprue Bar	
Standard sprue bars are solid sprue extensions that connect the hot runner with the machine nozzle.	
Split Sprue Bar	
Split sprue bars allow free access to the molding surface without obstruction.	
Back-to-Back Valve Gate	
Back-to-Back valve gates are available with standard and split sprue bars.	

Thermal Gate Consideration

Available for:

Ultra 250, Ultra 350, Ultra 500, Ultra 750, Ultra 750 UP and Ultra 1000 For all thermal gating methods, the nozzles can be positioned back-to-back or staggered

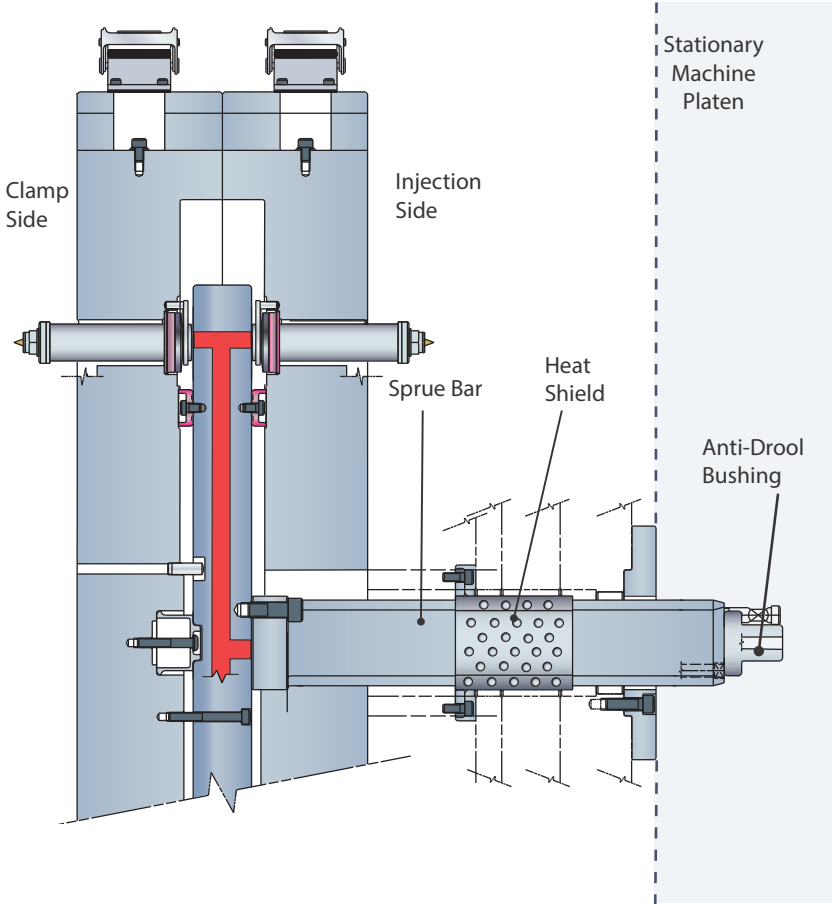

Minimum shutheights for stack systems will vary based on the requirements of the application. Please consult Application Engineering to determine the minimum shutheight for your application

Valve Gate Consideration

Available for:

Ultra 350, 500, 750, 1000; as well as Ultra Helix 250, 350, 500 and 750 In order to accommodate customer requirements Ultra VG nozzles can be positioned back-to-back using a 3 plate hot runner design

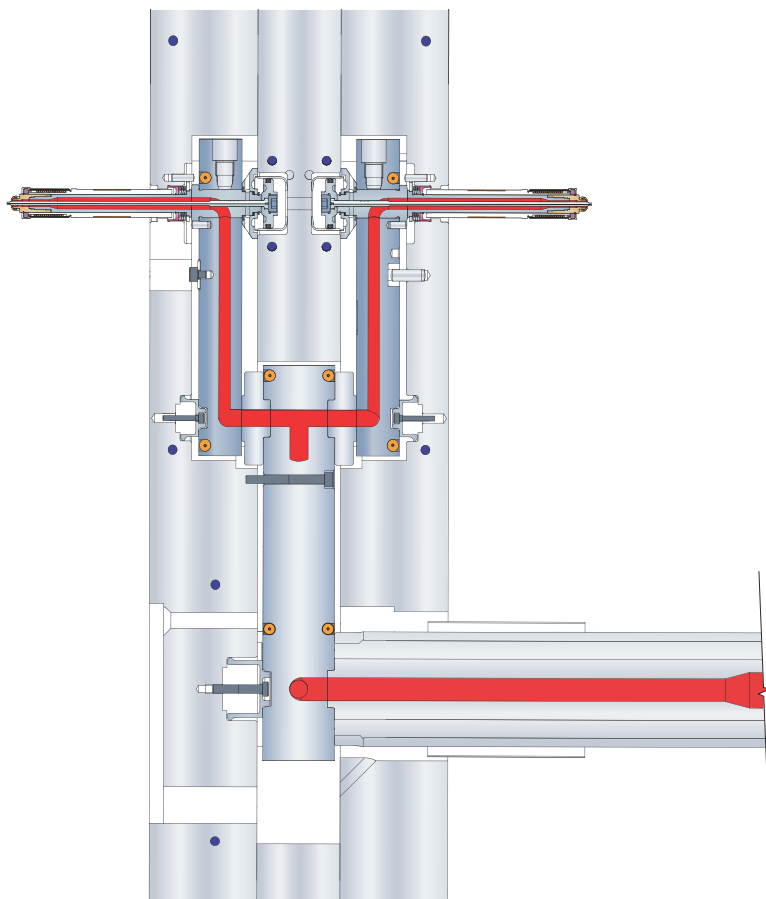

Back-to-Back

Minimum shutheights for stack systems will vary based on the requirements of the application. Please consult Application Engineering to determine the minimum shutheight for your application

Husky can provide offset stack valve gates as an option to address parts requiring this gating location or to provide a reduced shutheight. For further details and options please consult Application Engineering

Sprue Bar

Standard Sprue Bar

The purpose of the sprue bar is to transfer the molten resin from the machine injection unit to the center section. When the mold is in the closed position, the machine nozzle seats against the sprue bar. When the mold opens the sprue bar moves with the center section and disengages from the machine nozzle.

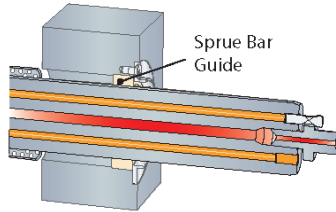

- Husky calculates the correct sprue bar length based on the mold shutheight and the required mold opening stroke. This ensures that the end of the sprue bar remains guided in the stationary platen when the mold is in the open position and that it will not contact the machine nozzle prematurely on mold close
- The sprue bar is aligned to the machine nozzle by the sprue bar guide, which is installed behind the locating ring, or on the cavity plate. To prevent damage during operation, the sprue bar must not pull out of the sprue bar guide during the mold opening stroke

Anti-Drool Bushing

The function of the anti-drool bushing is to minimize the amount of resin that drools out of the sprue bar when it is not in contact with the machine nozzle. As the sprue bar moves with the center section during mold open, the residual melt pressure in the manifold forces the anti-drool bushing backward

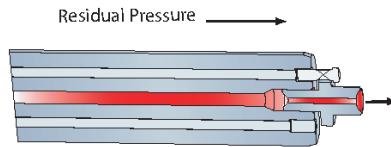

Husky has two types of anti-drool bushings: Anti-Drool and Ball Check Anti-Drool. Both have a second configuration where the sliding feature is removed so the bushing acts as an end cap. If desired, the ball can also be removed from the Ball Check Anti-Drool bushing for similar performance as the standard Anti-Drool bushing. Please see below for the application of each type.

Applied on:	Hot Tip Hot Runners		Valve Gate Hot Runners	
Machine Interface	Anti-Drool	End Cap	Ball Check Anti-Drool	Ball Check End Cap

Standard Sprue Bar Installations

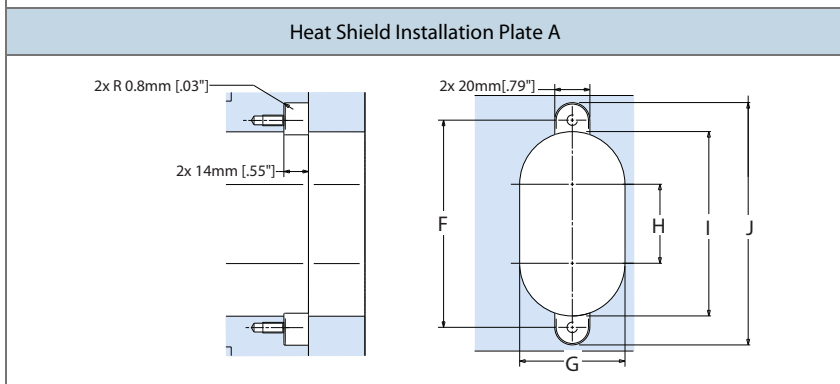
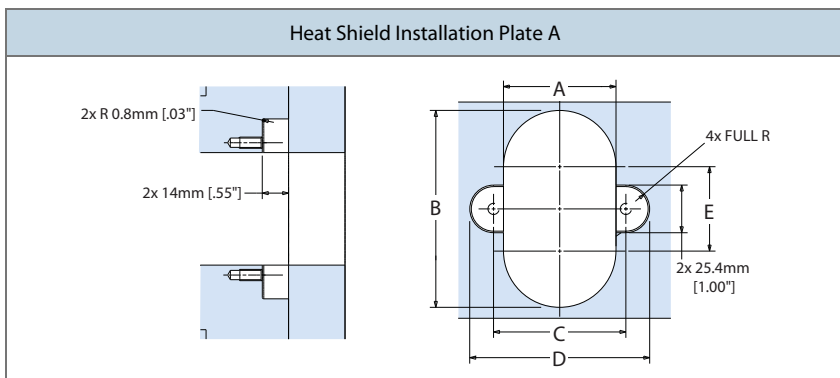

Dimension	Small	Medium	Large
A	35mm [1.38"]	50mm [1.97"]	60mm [2.36"]
B	73mm [2.87"]	100mm [3.94"]	105mm [4.13"]
C	47.6mm [1.87"]	62.8mm [2.47"]	70.6mm [2.78"]
D	73mm [2.87"]	78.2 [3.07"]	90mm [3.54"]
E	38mm [1.50"]	50mm [1.97"]	45mm [1.77"]
F	90mm [3.54"]	120mm [4.72"]	118mm [4.65"]
G	35mm [1.38"]	50mm [1.97"]	60mm [2.36"]
H	38mm [1.50"]	50mm [1.97"]	45mm [1.77"]
I	73mm [2.87"]	100mm [3.94"]	105mm [4.13"]
J	110mm [4.33"]	140mm [5.51"]	138mm [5.43"]

Standard Sprue Bar Installations

Sprue Bar Thru Hole Installation in Core Plates		Locating Installation Ring	
Dimension	Small	Medium	Large
A	2x R 17.5mm [.69"]	2x R 25mm [.98"]	2x R 30mm [1.18"]
B	35mm [1.38"]	50mm [1.97"]	60mm [2.36"]
C	2x 19mm [.75"]	2x 25.4mm [1.00"]	2x 22.5mm [0.89"]
D	38mm [1.5"]	50mm [1.97"]	45mm [1.77"]
E	Ø 140mm ± 0.02mm Ø [5.51" ± .0008"]	Ø 140mm ± 0.02mm Ø [5.51" ± .0008"]	Ø 140mm ± 0.02mm Ø [5.51" ± .0008"]
F	Ø 69.85mm ± 0.03mm Ø [2.75" ± .001"]	Ø 100mm ± 0.03mm Ø [3.94" ± .001"]	Ø 108mm ± 0.03mm Ø [4.25" ± .0001"]
G	R 0.8mm [.03"]	R 0.8mm [.03"]	R 0.8mm [.03"]
H	R 0.8mm [.03"]	R 0.8mm [.03"]	R 0.8mm [.03"]
I	-	2x MB	2x MB
J	6mm [0.24"]	6mm [0.24"]	6mm [0.24"]
K	Ø 19mm ± 0.03mm Ø [0.75" ± .0001"]	Ø 19mm ± 0.03mm Ø [0.75" ± .0001"]	Ø 24mm ± 0.03mm Ø [0.94" ± .0001"]

Standard Sprue Bar Pressure Limits

Size	Metric	Imperial
Large (22.23mm [0.875"])	124 MPa	18K psi
Medium (18.26mm [0.718"])	76 MPa	11K psi
Medium (16mm [0.629"])	124 MPa	18K psi
Small (14.29mm [0.562"])	97 MPa	14K psi
Small (11.5mm [0.452"])	241 MPa	35K psi

Offset Sprue Bar

When the sprue bar can not be positioned at the mold centerline, an offset sprue bar can be used. Using an offset sprue bar requires additional mold shutheight to accommodate the transfer manifold attached to the stationary platen. The sprue bar can be positioned at any side of the mold.

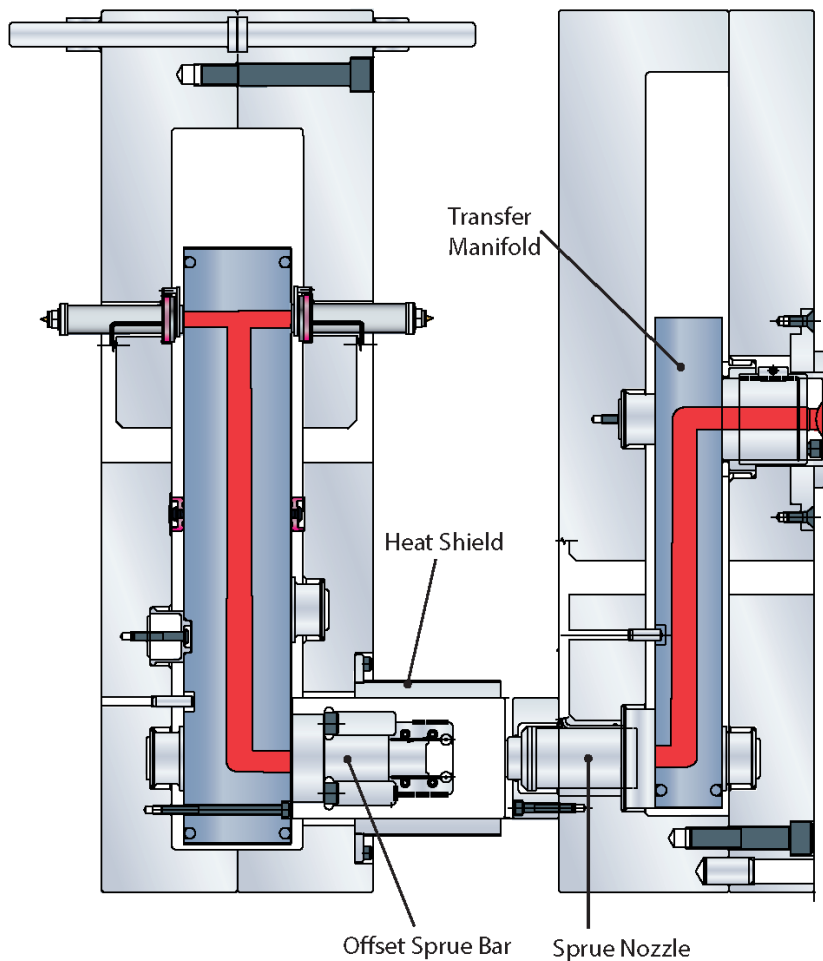

Split Sprue Bar

The Split Sprue Bar transfers resin from the machine injection nozzle to the hot runner of a stack mold. The transfer is designed to free the parting line from component interference while preventing resin leakage. The Split Sprue Bar accomplishes this through the connection of two independently controlled assemblies enclosed within the mold. These assemblies interface with each other at the parting line during mold closed and disengage upon mold open. This makes free drop of parts possible and allows unrestricted robot access for part take-off.

There are two Split Sprue Bar configurations: Inline and Offset. Located in the center of the mold, the Inline version is mounted co-axially with the machine nozzle. Resin flows through the inline valve gate unit mounted in the core backing plate and transfers melt to the moving side split sprue bar assembly through the tip interface at the parting line. The Offset Split Sprue Bar employs a transfer manifold system mounted to the stationary platen to route flow from the injection nozzle to a Split Sprue Bar unit located at a place of convenience to the mold design.

Please note that Split Sprue Bar stack systems are not sold as manifold systems

Key Features:

Taper stem shut-off

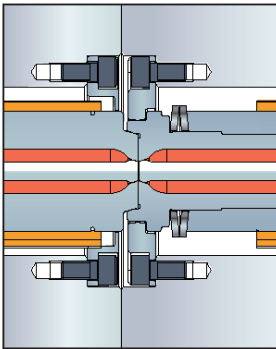

Radial taper at nozzle lead-in for alignment

Patented sliding joint

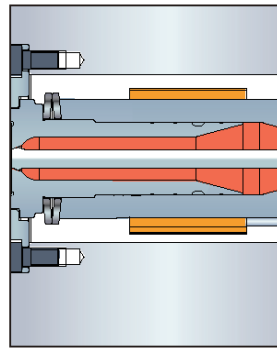

Sliding joint with spring packs for robustness

Split Sprue Bar

Two standard throughput options are available, “Medium” and “Large”. Husky’s Application Engineering personnel can assist in the selection of the proper throughput option for your system.

The *Large Split Sprue Bar* is available in an *Offset configuration only*.

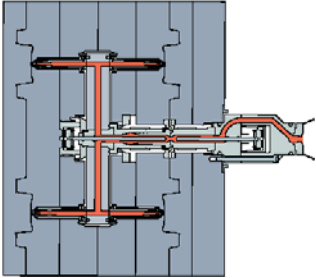
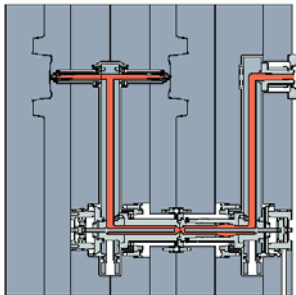
System Type	Description	Sizes available	Section View
Inline	The Split Sprue Bar is located on the centerline of the mold and is directly fed by the machine nozzle	Medium 2068 bar [30k psi]	
Offset	An offset system allows the Split Sprue Bar unit to be positioned freely in the mold frame. A transfer manifold routes the feed from the machine nozzle to the Split Sprue Bar unit	Medium (Transfer manifold) 2068 bar [30k psi] Large (Transfer manifold) 1861 bar [27k psi]	

Section View

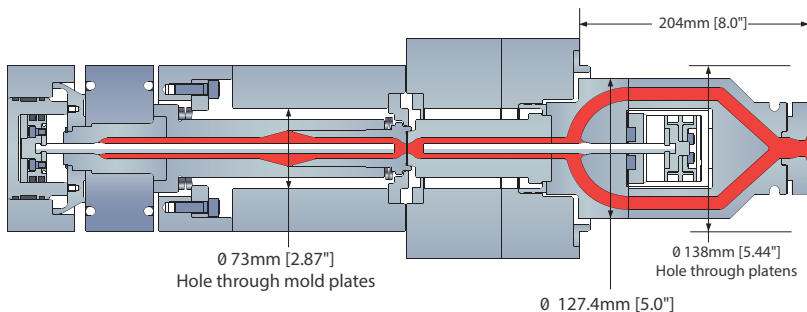

Minimum Shutheight

- Medium Split Sprue Bar = 200mm [7.87"]
- Large Split Sprue Bar = 216mm [8.50"]

Projects require application review prior to quoting, call Hot Runner Sales Support team for pricing

Split Sprue Bar

Max Throughput (g/sec.)

		Medium	Large
Viscosity	Low	800	1100
	Medium	600	900
	High	300	600

Material Compatibility

Resin	Split Sprue Bar	Resin Structure
ABS	◇	A
Flex. PVC	◇	A
PA	◇	SC
PA (33% GF)	◆	SC
PBT	◇	SC
PBT/PC	◇	B
PC	◇	A
PC/ABS	◇	B
PE	✓	SC
PEI	◆	A
PET	◇	SC
PETG	◇	A
PMMA	◇	A
POM	◇	SC
PP	✓	SC
PPO (PPE+PS/PA)	◆	A/SC
PS	✓	A
PSU	◆	A
SAN	◇	A
TPE	✓	A
TPO	◇	A
TPUR	◇	A

Application Compatibility

Resin	Split Sprue Bar
Abrasive	◇
Color Change	✓

✓ – Recommended

SC – Semi-Crystalline

◇ – Requires Review

B – Blend

◆ – Not Recommended

A – Amorphous

Note: Information subject to change

Note: An increase in pressure may be required for Split Sprue Bar vs. a conventional sprue bar

Split Sprue Bar

General Molder Considerations

Operating a Split Sprue Bar, the molder might observe some performance differences compared to a Conventional Sprue Bar. For certain applications, this could include an expected temperature overshoot at the split line of the Split Sprue Bar, caused by shear.

Husky recommends

- The end user to stock at least one of each custom item. Husky will quote the parts that are recommended to have on-hand
- That each Split Sprue Bar valve stem gets controlled by a separate air circuit in order to shut the center section stem first (after machine decompression) and then the stationary side one, 0.2 seconds later
- To lap each Split Sprue Bar stem to the corresponding tip for a very good fit. This is done on new systems before leaving Husky
- To reduce the carriage pressure as much as possible during mold open, while still maintaining a positive seal. This eliminates the additional stress on the molds stationary half
- The inlet diameter of the machine injection nozzle to be 14.29mm [0.56 in]. This applies only for or inline split sprue bars
- To adjust the mold protection to compensate / overcome the additional load of approximately 1,000 lbf (4,448 Newton) that will be generated during the last one millimeter of mold closing stroke

Additional molder and moldmaker information is available from Husky

Area	Detail	Action	When
Split Sprue Bar General	Main Sprue and Locating Ring	Inspect for visible damages; remove and clean resin deposits	Weekly
	Split Sprue Bar Split Line		Daily for the first week of operation, then extended steps (to establish timing)
	Sliding Bushing and Nozzle Base	Inspect interface for potential weepage and clean up	Daily for the first week of operation, then extended steps (to establish timing)
		Clean bushing and visually inspect for damages	2M Cycles or 12 Months
	Replace Sliding Bushing and Inspect Nozzle Base	4M Cycles	
Wedge Collars	Replace Wedge Collars	4M Cycles	
Stationary Side Split Sprue Bar	Sprue Body	Inspect for potential weepage and clean up	2M Cycles or 12 Months
		Replace Piston Seals, O and C rings	2M Cycles
		Clean Stem and visually inspect for damages	2M Cycles or 12 Months
	Split Sprue Bar Nozzle Tip	Clean Stem and visually inspect for damages	2M Cycles or 12 Months
		Husky Refurbishment	4M Cycles or 37 Months

Split Sprue Bar

Preventive Maintenance - Hot Runner & Split Sprue Bar

Area	Detail	Action	When
Center Section Split Sprue Bar	Split Sprue Bar Valve Stem S/A	Clean and visually inspect for damages	2M Cycles or 12 Months
		Replace Piston Seals	2M Cycles
		Husky Refurbishment	4M Cycles or 37 Months
Electrical Inter- face	Connector Inserts and Connector Hoods	Inspect for visible damage	Weekly
		Measure heater resistance, isolation resistance and ground wire connection of all heating elements	2M Cycles or 12 Months
Nozzle Front	Nozzle Tip, Tip Insulator, Nozzle Heater and Thermocouple	Visually inspect for damages; clean resin deposits at sealing interface	2M Cycles or 12 Months
		Husky Refurbishment	4M Cycles or 37 Months
Pocket Manifold	General	Inspect for potential weepage and clean up	2M Cycles or 12 Months
	Valve Stem S/A	Clean and visually inspect for damages	2M Cycles or 12 Months
		Replace Piston Seals	2M Cycles
		Husky Refurbishment	4M Cycles or 37 Months
	Back-up Pad	Clean weepage holes	2M Cycles or 12 Months
		Visually inspect	2M Cycles or 12 Months
	C-Rings	Replace	After each back-up pad removal
	Guide Pins	Visually inspect and Grease	After each latch over
Husky Refurbishment		4M Cycles or 37 Months	

- The PM intervals are an initial recommendation of Husky, based on other applications, utilizing the same hardware
- The application itself (resin, pressures, temperatures, ...) and the processing environment do significantly impact the final cleaning or replacement cycle for a Molding System
- We will work with our Split Sprue Bar Customers to further optimize and precise those recommendations in order to achieve the best compromise between cost control and production security



In this section:

Page

9-1Overview

9-2 System Details

9-3 Installation Reference

9-3 Stem Stroke

Overview

Ideal for Automotive parts

- One step installation
- Easy maintenance: one step removal from the mold
- Leak-proof UltraSeal technology
- Available with new hydraulic or pneumatic valve stem actuator
- Dedicated and independent connector plates for water, oil or air, and electric wires
- Electrical-water-oil or air connectors can be installed to meet customer requirements
- Nozzles are positioned to perfectly fit the mold seat
- No need to heat the system during installation
- No need to align nozzle with seat
- Reduced risk of damage to the tips during installation

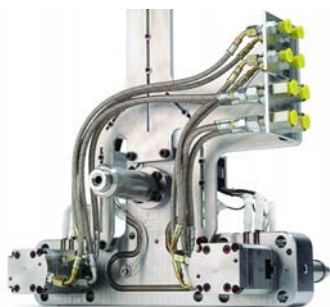

Back



Front

- Customized, rigid services frame:
- Matches the manifold and mold layout
- Easy handling of the system during installation and maintenance
- Connector plates rigidly fixed to the frame
- If systems is more than 12 drops please contact Husky

System Details

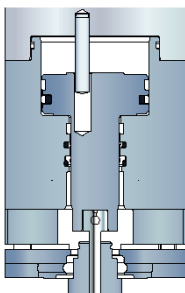

- Actuator: easy to install and maintain
- Integrated cooling lines for hydraulic actuation
- Keyed stem and piston
- Easy to remove: allows fast access to stem without exposing hydraulic oil

System Details



- Leak-proof retaining system
- Husky standard nozzle stack
- Proven performance

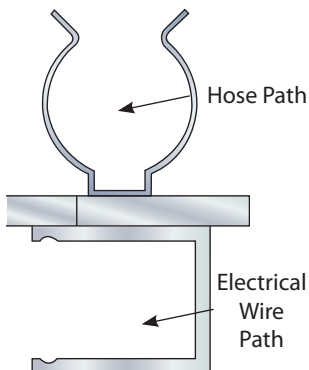

- Standard clips for wire and hose:
 - Easy to replace
- Independent paths for wire and hoses:
 - easy to maintain separately

Installation Reference

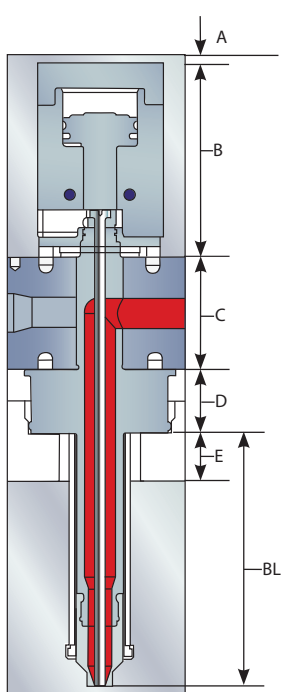

Nozzle Size	Gate Style	Actuation	A	B	C	D	E	BL Dim
Ultra 1000	VG	Hydraulic	5mm [0.19"]	104mm [4.09"] W/2mm [.07"] Shim	45-80mm [1.77- 3.17"]	35mm [1.37"]	25mm [0.98"]	77- 315mm [3.03-12.4"]
Ultra 1000	VG	Pneumatic		84.5mm [3.32"]	45-80mm [1.77- 3.17"]	35mm [1.37"]	25mm [0.98"]	77- 315mm [3.03-12.4"]
Ultra 1000	HT	None		18mm [0.70"]	45-80mm [1.77- 3.17"]	27mm [1.06"]	25mm [0.98"]	77- 315mm [3.03-12.4"]
Ultra 750 Ultra Helix 750	VG	Hydraulic (Lg)		104mm [4.09"] W/2mm [.07"] Shim	40-80mm [1.57- 3.17"]	31mm [1.22"]	17mm [0.66"]	48- 300mm [1.61-11.8"]
Ultra 750/ Ultra Helix 750	VG	Hydraulic (Sm)		89.2mm [3.51"] W/1.5mm [.06"] Shim	40-80mm [1.57- 3.17"]	31mm [1.22"]	17mm [0.66"]	48- 300mm [1.61-11.8"]
Ultra 750	VG	Pneumatic		82mm [3.22"]	40-80mm [1.57- 3.17"]	31mm [1.22"]	17mm [0.66"]	48- 300mm [1.61-11.8"]
Ultra 750	HT	None		14mm [0.55"]	40-80mm [1.57- 3.17"]	25mm [0.98"]	17mm [0.66"]	51- 300mm [2.0-11.8"]

Installation Reference

Manifold Leg

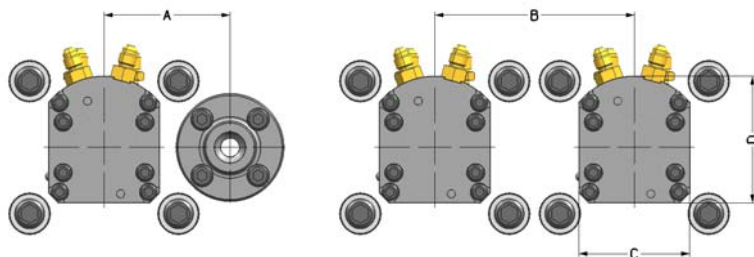

Nozzle Size	Gating Style	Actuation	Stroke	A	B	C	D
Ultra 1000	VG	Hydraulic	13.8mm [0.54"]	76.2mm [3.00"]	120.65mm [4.75"]	67mm [2.63"]	76.5mm [3.01"]
Ultra 1000	VG	Pneumatic	13.8mm [0.54"]	76.2mm [3.00"]	120.65mm [4.75"]	67mm [2.63"]	76.5mm [3.01"]
Ultra 1000	HT	None	None	76.2mm [3.00"]	101.6mm [4.00"]	None	None
Ultra 750	VG	Hydraulic (Lg)	13.8mm [0.54"]	76.2mm [3.00"]	120.65mm [4.75"]	67mm [2.63"]	76.5mm [3.01"]
Ultra 750/ Ultra Helix 750	VG	Hydraulic (Sm)	12.42mm [0.48"]	63.5mm [2.50"]	101.6mm [4.00"]	53mm [2.09"]	64.5mm [2.53"]
Ultra 750	VG	Pneumatic	12.42mm [0.48"]	63.5mm [2.50"]	101.6mm [4.00"]	55mm [2.16"]	80mm [3.15"]
Ultra 750	HT	None	None	63.5mm [2.50"]	76.2mm [3.00"]	None	None

Stem Stroke

	Large Hydraulic	Small Hydraulic	Large Pneumatic	Small Pneumatic	Small Hydraulic Short Stroke
Stem Stroke	13.6mm [0.53"]	12.4mm [0.48"]	13.6mm [0.53"]	12.4mm [0.48"]	7.4mm [0.29"]

In this section:

Page

10-1 Overview

10-3 Installation Reference

Overview

Perfect to mold parts with optical or high aesthetic requirements

- Ideal for Automotive Lighting applications
- Angled manifold to place the Nozzle in the best gating position for the part
- Lucent™ includes UltraSeal® technology with a 3 years leak-proof warranty
- Easy installation: manifolds are bolted directly on the cavity
- Independent actuators available in Pneumatic and Hydraulic versions
- Easy access and maintenance



Easy Maintenance, simple Actuator Removal

- Full access to the stem
- Do not require to uninstall the system from plates / mold

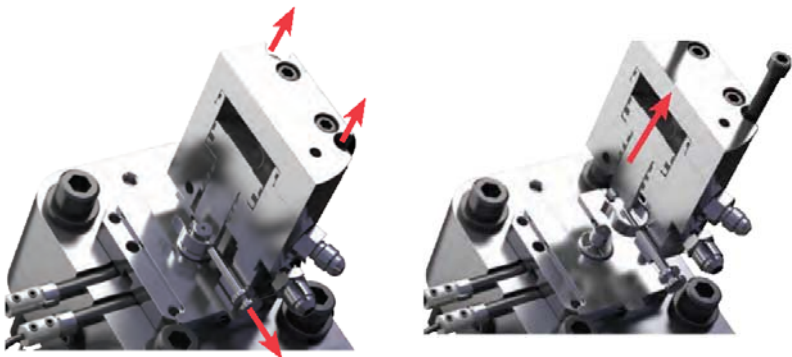

Overview

Main Technical Features

1. Specialized steel and proprietary coating to avoid polycarbonate degradation
2. New shoulder designed to minimize the thermal losses
3. Jacket heaters easy to replace
4. Nozzle tip design with four different material combinations leads to best thermal insulation and the lowest dissipation with the mold

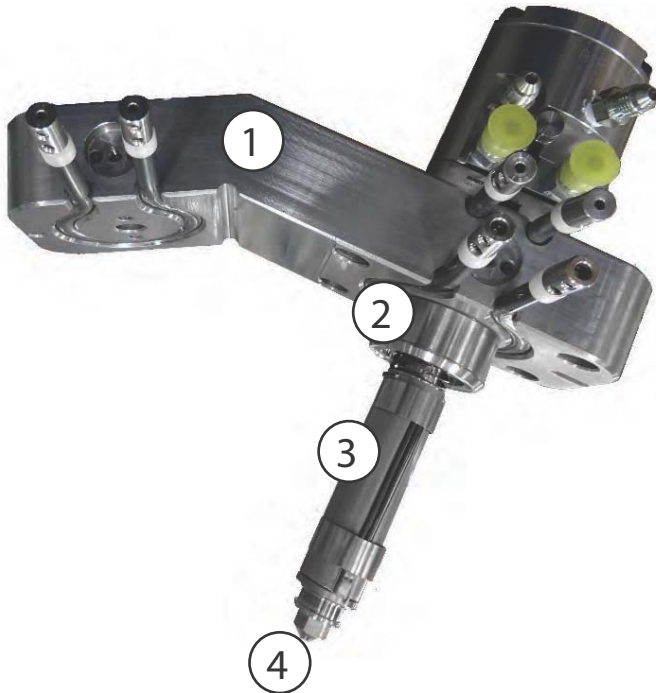

Installation Reference

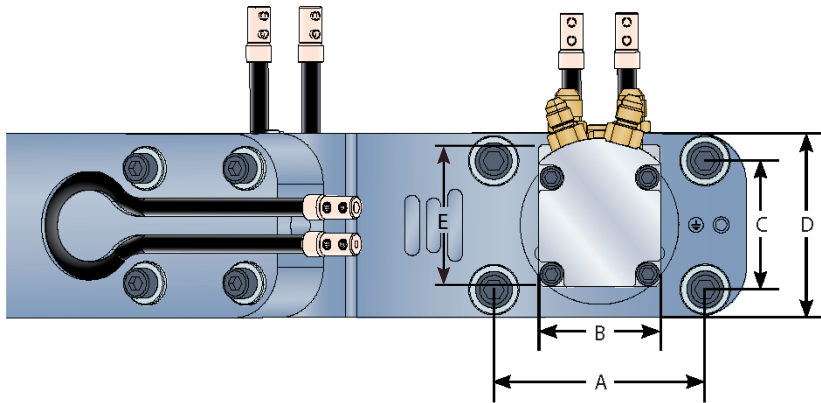

Nozzle Size	Gating Style	Actuation	Stroke	A	B	C	D	E
Ultra1000	VG	Hydraulic	13.8mm [0.54"]	96mm [3.78"]	67mm [2.64"]	58mm [2.28"]	85mm [3.35"]	76.5mm [3.01"]
Ultra1000	VG	Pneumatic	13.8mm [0.54"]	96mm [3.78"]	67mm [2.64"]	58mm [2.28"]	85mm [3.35"]	76.5mm [3.01"]
Ultra 1000	HT	None	None	96mm [3.78"]	None	58mm [2.28"]	85mm [3.35"]	None
Ultra 750	VG	Large Hydraulic	13.8mm [0.54"]	92mm [3.62"]	67mm [2.64"]	54mm [2.13"]	80mm [3.15"]	76.5mm [3.01"]
Ultra 750	VG	Small Hydraulic	12.42mm [0.48"]	92mm [3.62"]	53mm [2.09"]	54mm [2.13"]	80mm [3.15"]	64.5mm [2.53"]
Ultra 750	VG	Small Hydraulic (Short Stroke, APP)	7.42mm (APP) [0.29"]	92mm [3.62"]	53mm [2.09"]	54mm [2.13"]	80mm [3.15"]	64.5mm [2.53"]
Ultra 750	VG	Pneumatic	12.42mm [0.48"]	76mm [2.99"]	55mm [2.17"]	54mm [2.13"]	80mm [3.15"]	80mm [3.15"]
Ultra 750	HT	None	None	76mm [2.99"]	None	54mm [2.13"]	80mm [3.15"]	None

Installation Reference

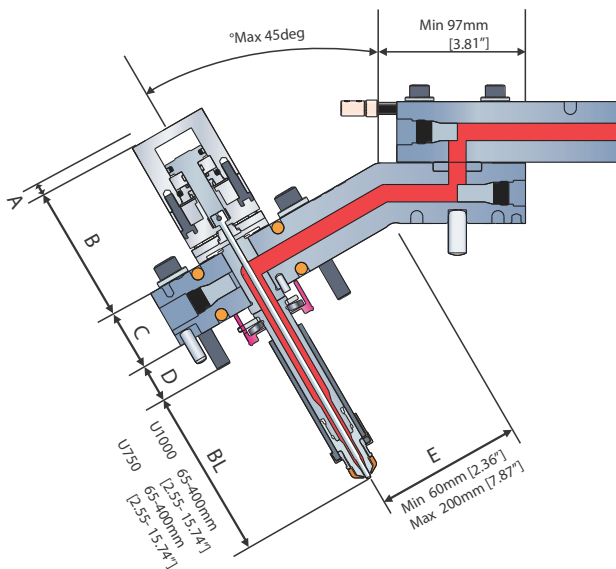

Nozzle Size	Gating Style	Actuation	Stroke	A	B	C	D
Ultra1000	VG	Hydraulic	13.8mm [0.54"]	5mm [0.19"]	103.5mm [4.07"] W/1.5mm [0.06"] Shim	45-60mm [1.77-2.36"]	26.5mm [1.04"]
Ultra1000	VG	Pneumatic	13.8mm [0.54"]		84.5mm [3.32"]		26.5mm [1.04"]
Ultra 1000	HT	None	None		18mm [0.70"]		18.75mm [0.74"]
Ultra 750	VG	Large Hydraulic	13.8mm [0.54"]		103.5mm [4.07"] W/1.5mm [0.06"] Shim	40-60mm [1.57-2.36"]	22.623mm [0.89"]
Ultra 750	VG	Small Hydraulic	12.42mm [0.48"]		89mm [3.5"] W/1.5mm [0.06"] Shim		22.623mm [0.89"]
Ultra 750	VG	Small Hydraulic (Short Stroke, APP)	7.42mm (APP) [0.29"]		79mm [3.11"] W/1.5mm [0.06"] Shim		22.623mm [0.89"]
Ultra 750	VG	Pneumatic	12.42mm [0.48"]		82mm [3.22"]		22.623mm [0.89"]
Ultra 750	HT	None	None		14mm [0.55"]		16.623mm [0.65"]

Installation Reference

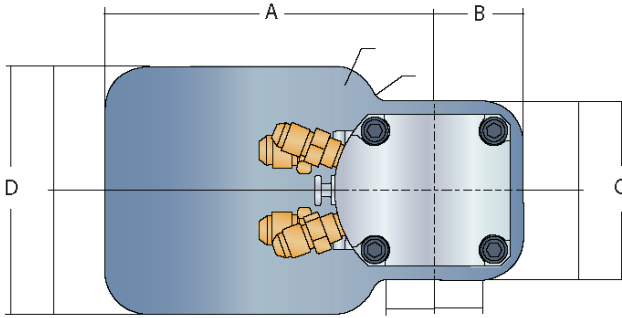

Nozzle Size	A	B	C	D
Ultra 1000	120mm [4.72"]	38.5mm [1.51"]	77mm [3.03"]	95mm [3.74"]
Ultra 750	120mm [4.72"]	32.5mm [1.27"]	65mm [2.55"]	90mm [3.54"]

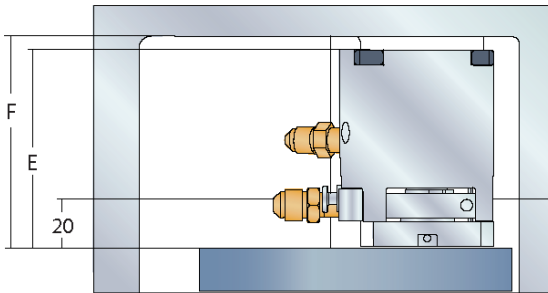

Nozzle Size	Actuation	C	D
Ultra 1000	Pneumatic	84.6mm [3.33"]	90mm [3.54"]
	Hydraulic	103.4mm [4.07"]	109mm [4.29"]
Ultra 750	Pneumatic	82.2mm [3.21"]	88mm [3.46"]
	Hydraulic	103.4mm [4.07"]	109mm [4.29"]
	Small Hydraulic	89.2mm [3.51"]	95mm [3.74"]
	Hydraulic Short Stroke (APP)	79.2mm [3.11"]	85mm [3.34"]

In this section:

Page

11-1 Flow Simulation

11-2 Refurbishment

Flow Simulation

Flow Simulation Service Capabilities

Consulting Services

Husky's Flow Simulation Center (FSC) offers a full range of flow simulation consulting services to evaluate the filling, packing and cooling phases of the injection molding process and predict part warpage upon ejection. See the capabilities chart for a complete listing of our offerings. A customized report of the provided service will be supplied to the customer.

	MPA (Basic fill analyst)	MPI (Advanced fill services)
Cavity Pressure	X	X
System Pressure		X
Identify Filling Issues		X
Air Trap Location		X
Air Trap Elimination		X
Weld Line		X
Weld Line Elimination		X
Hot Runner Balancing		X
Gate Location Optimization		X
Clamp Tonnage Prediction		X
Cooling Optimization		X
Warpage Prediction		X
Material Selection/Optimization		X
Injection Time Evaluation	X	X
Sequential Gating		X
Wall Thickness Optimization		X
Cold Runner Optimization		X
Packing Phase Simulation		X
Cooling Phase Simulation		X
Core Deflection		X

- MPA is intended for **fast validation** of a model during part design
 - Results are best suited for part with low to medium complexity
- MPI is intended for **optimization** of the part and mold
 - Provides significantly more detailed results
 - Addresses complex part designs

For more information contact your Hot Runner Sales Support Flow Simulation Team

Refurbishment

Manifold & Components (no plates)

Manifold cleanings is a joint maintenance effort between the customer and Husky. The customer performs a complete disassembly of the project and sends the manifolds and stack components to Husky for cleaning and inspection.

Components to be returned

Manifold(s), Manifold bushings, Manifold backup pads, Sprue bushing/ Sprue bar, Nozzle housings, Nozzle stacks, Electrical components, Valve Stems (VG)

Complete Hot Runner

Husky's hot runner cleaning service offers a complete hot runner cleaning with component replacement on an "as needed" basis. Husky performs a complete disassembly and inspection of the hot runner followed by a recommendation for replacement parts or rework.

Components to be returned

Complete hot runner

Platinum refurbishment for Hot runner systems

Additional to HUSKY's complete Hot runner refurbishment your system can be handled with platinum approach. This provides you, additional to the standard refurbishment services, with following advantages

- Fix delivery date / reduced lead time
- Discounted Price certainty from the start
- Full renew of the 3 year "LEAK FREE" warranty on your system
- Replacement of the most critical components to ensure "Plug & Play" to minimize your production loss

Components to be returned

Complete hot runner

Refurbishment

		Manifold & Components	Compl. Hot Runner	Platinum*	
Scope of Work	Disassembly & Cleaning	Review of reported issues	—	●	
		Compl. Hot Runner disassembly	N/A	●	
		Cleaning process	●	●	●
		Cleaning debris HR plates	N/A	●	●
		Fluidized bed cleanngn of all components	●	●	●
		Extrude hone melt channels	●	●	●
		Wash cycle to remove extrude media	●	●	●
	Inspection	Visual inspection of sealing surfaces	●	●	●
		Measurement of plate installation	N/A	●	●
		Resitens check of elec. Components	*	●	●
		Individual nozzle comp, inspection	●	●	**
		Manifold bushing ID check (VG)	●	●	**
		Valve stem OD check (VG)	●	●	**
	Reassembly & Tests	Complete HR Assembly	N/A	●	●
		Verification of system preload	N/A	●	●
		Tip height inspection	N/A	●	●
		Sealing test (Water) of plates	N/A	●	●
		Sealing test (Air) of plates (VG)	N/A	●	●
		Valve stem height & actuation (VG)	N/A	●	●
		Functional check of elctrical comp. (Heat test)	N/A	●	●
		Assembly certificate	N/A	●	●

* Manifold heater

** Mandatory part exchange

Refurbishment

		Manifold & Components	Compl. Hot Runner	Platinum*	
Scope of Work	Additional Services	Review of reported issues	—	—	●
		Exchange of cylinder & pistons included	—	—	●
		Exchange of valve stems included	—	—	●
		Exchange of manifold bushings included	—	—	●
		Exchange of nozzle housings included	—	—	●
		Exchange of nozzle tips included	—	—	●
		Exchange of up to 20% of nozzle heater included	—	—	●
		Exchange of all seals included	—	—	●
		Six month part warranty on all comp. exchanged	●	●	●
		Full renewed "LEAK FREE" warranty	—	—	●

* Requires minimum 2 weeks notice prior to start

Your direct contact for all support for Husky® REFURBISHMENT is your partner at your local HUSKY Call center

Warranty

- Renewal of the Husky 3 year leak-proof warranty.
 - Applies for Hot Tip & Valve Gated Hot Runners
 - The warranty is subject to the replacement of all components highlighted from Husky during the initial inspection.
- A 6 month warranty is applied on replacement parts
- Please refer as well to our general terms & conditions

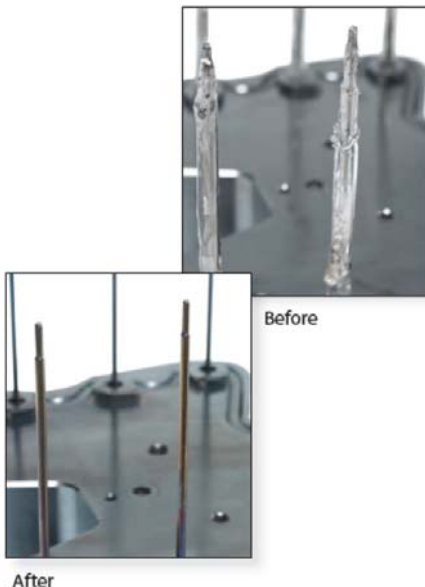

Refurbishment

Hot Tip

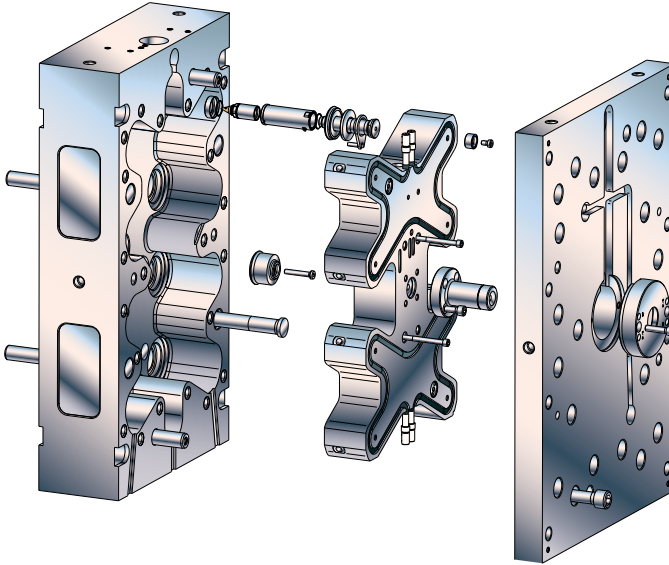

Maintenance Task	6 Months	1 Year	3-4 Years
Clean and visually inspect nozzle tip insert, tip retainer seal-off diameter, and tip insulator	✓		
Clean and visually inspect sprue bushing	✓		
Perform a meter check on all electrical against the provided electrical schematic	✓		
Remove manifold backing plate; Visually inspect for plastic leakage		✓	
Remove water fittings and check for corrosion deposits within channels; Analyze water if necessary		✓	
Clean and visually inspect locating ring		✓	
Inspect manifold heater and heater insulation		✓	
Remove manifolds and nozzle stacks from plates; Clean and inspect melt channels.			✓
Replace center locating insulator, nozzle disc springs, and back up pads			✓
Replace nozzle tip inserts, tip retainers, and tip insulators			✓
Remove sprue bushing; Clean melt channel and rework spherical radius			✓
Replace sprue heater and thermocouple			✓

Refurbishment

Valve Gate

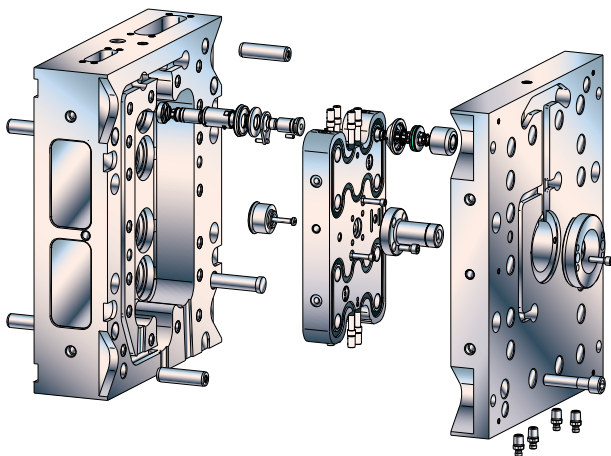

Maintenance Task	6 Months	1 Year	3-4 Years
Clean and visually inspect nozzle tip retainer, tip insulator, and valve stem	✓		
Clean and visually inspect sprue bushing	✓		
Perform a meter check on electrical components; Verify electrical readings to electrical schematic	✓		
Remove manifold backing plate; Clean plastic leakage around valve gate back up pad/ manifold surface	✓		
Remove valve gate cylinder and piston assembly; Clean and visually inspect air sealing surfaces	✓		
Clean and inspect valve gate piston; Replace valve gate piston seal		✓	
Remove water fittings and check for corrosion deposits within channels; Analyze water if necessary		✓	
Clean and visually inspect locating ring		✓	
Inspect manifold heater and heater insulation		✓	
Remove manifolds and nozzle stacks from plates; Clean and inspect melt channels.			✓
Replace center locating insulator, nozzle disc spring, and back-up pad			✓
Replace nozzle tip retainer, tip insulator, and valve stem			✓
Remove sprue bushing; Clean melt channel and rework spherical radius			✓
Replace sprue heater and thermocouple			✓

In this section:

Page

12-1 Controller Overview

12-3 Key Advantages

12-9 FTO (Finish to Order)

12-10 Dimensions

Controller Overview

Altanium Operator Interfaces

Neo5*

1-48 Zones



- Full featured hot runner temperature control
- Optimized for 2-16 Cavity Applications
- 10" Color Touchscreen

Delta5**

1-128 Zones



- Full featured HR temperature control and optional UltraSync-E or Valve Gate Sequencer control.
- Optimized for 24-96 Cavity Applications
- 15.6" Color Touchscreen

Matrix5***

1-255 Zones



- Full featured HR temperature control w/ optional integrated UltraSync-E, Valve Gate Sequencer, Individual Servo Valve Gate or Mold Servo Control
- Optimized for >96 Cavity Applications
- 22" Color Touchscreen

Altanium Cards and Mainframes

H-Series Control Cards



Interchangeable Across all Configurations
4z 5A, 2z 16A and 1z 30A

Neo5 Compact Mainframes



Small Foot Print with Integrated Interface
Up to 42z

Free Standing Mainframes



Standard and Custom Configurations
Up to 255z

*Neo5 can be retrofitted to existing 1-48 zone controllers (X, C, CX & A)

**Delta5 can be retrofitted to existing 1-128 zone controllers (X, C & CX only)

***Matrix5 can be retrofitted to existing 1-254 zone controllers (X, C & CX only)



All controllers have a 5 year warranty; this includes the interface, cards and mainframe.

Cards are in the process of being switched over from green to red

Controller Overview

Systematic Elimination of Process Variability

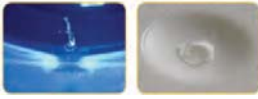
- Good temperature control helps molders to reduce scrap rates

Fill Balance	Gate Quality	Part Finish
Inconsistent part weight and dimensional stability	Stringing or crowning resulting in unacceptable parts	Resin degradation leading to black specs and streaking
		

- Altanium is a building block within an injection molding system that eliminates one process variable by accurately controlling the temperature of the melt in the hot runner system
- By utilizing an Altanium, users can achieve better melt stream management which contributes to a more capable system producing higher yields

Greater Accuracy and Repeatability

- Optimal temperature control is determined by three major influences:
 - Input signal quality
 - Control algorithm precision
 - Power output speed and uniformity
- Altanium employs Active Reasoning Technology (ART) to ensure that each of these elements are accounted for during the control process:

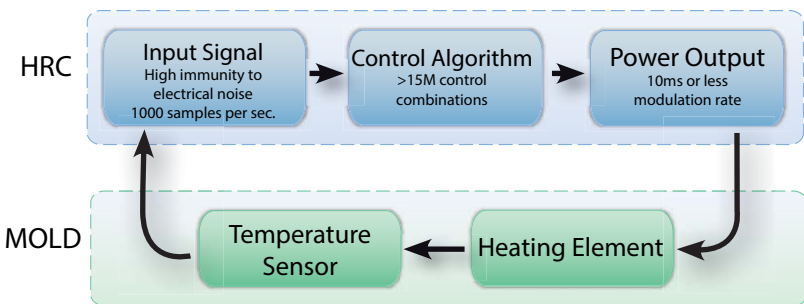

Key Advantages

ART-Active Reasoning Technology

ART delivers tighter control & less variability utilizing the following methods:

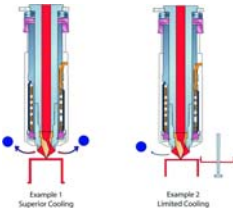
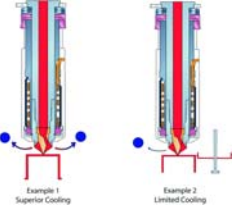
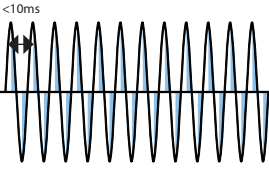
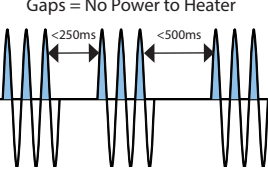
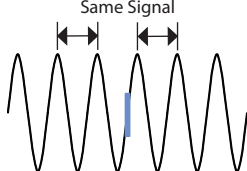
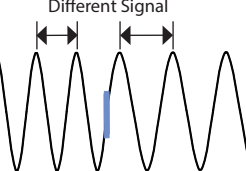
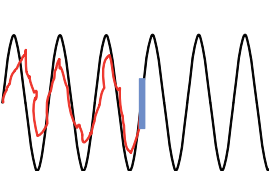
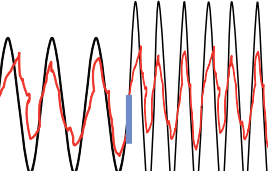
ART Advantage	Altanium	Others
<p>+15M Control Combinations: ART differentiates itself by having over 15 million control combinations available so it is able to generate a parameter set to precisely fit each zone's unique thermal response characteristics without having to rely on preset defaults based on heater classifications (e.g. tips, manifolds and sprues)</p>	 <p>Greater range of control algorithms to adjust to the specific thermodynamic conditions in gate area</p>	 <p>Control algorithm is limited in its ability to adapt to the different thermodynamic conditions in gate area</p>
<p>10ms or Less Modulation Rate: Once the optimal control algorithm is calculated, ART utilizes a modulation method that provides a uniform flow of power at a rate of 10 milliseconds or less, which greatly reduces the time when no energy is being delivered to the heater, resulting in minimal deviations in temperature</p>	 <p>Phase Angle modulation minimizes gaps in power output to heaters to under 10ms</p>	<p>Gaps = No Power to Heater</p>  <p>Large gaps in power output result in oscillations in temperature over time</p>
<p>1000 Samples per Second: Using a thermocouple oversampling technique the integrity of the temperature signal is ensured by taking a temperature measurement every 1 millisecond. This allows the algorithm to execute power changes based on the most accurate data</p>	<p>Same Signal</p>  <p>Oversampling ensures the temperature signal is reproduced at the same frequency</p>	<p>Different Signal</p>  <p>Under sampled temperature signal is reproduced at a different frequency</p>
<p>~100% Immunity to Electrical Noise: Additionally, the reliability of the temperature signal is preserved through a thermocouple circuit design that provides a high degree of immunity to electrical noise, regardless of the hot runner design or processing environment</p>	 <p>Isolation ensures noise on the line does not distort the temperature signal</p>	 <p>Lack of isolation allows noise on the line to distort the temperature signal</p>

Key Advantages

ART-Active Reasoning Technology (Continued)

Actual testing showed ART allowed processing setpoint to be reduced by 13°C [55.4 °F]

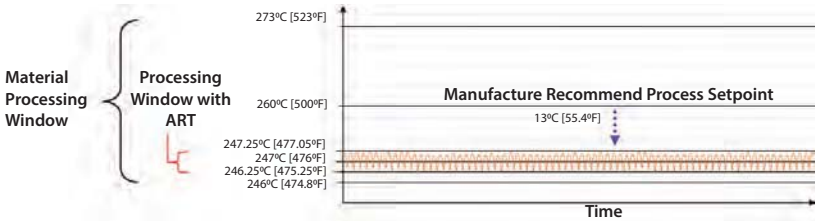

**Results from lab tests on several resin and applications, individual customers may experience different results*

- Benefit
 - More accurate and repeatable control with minimal cavity-to-cavity and shot-to-shot variability contributing to better part quality and process stability
 - Reduced process temperatures resulting in lower energy cost & faster cycles
 - Eliminates potential risk associated with electromagnetic interference emitted by servo motor systems found in electric molding machines

Easy to use

- Testing has shown that Altanium improves operational efficiency by 30%

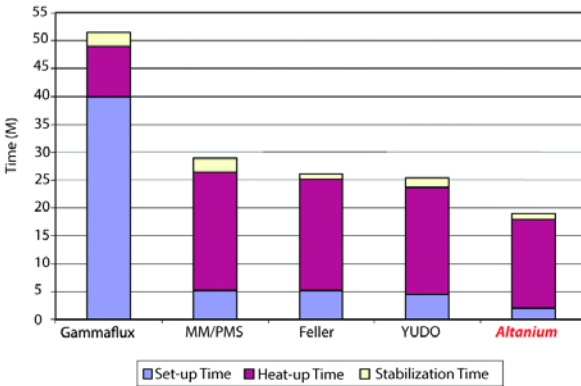

**Results from head to head comparison tests, individual customers may experience different results*

- Benefit
 - Flat screen navigation and color coding provide an intuitive interface that shortens the learning curve for new users
 - Automatic setup storage and recall ensures the same processing parameters are used for a mold without operator intervention
 - Multilingual interface increased user adoption regardless of what region the controller is operating

Key Advantages

Phase Angle and Zero-Cross Power Modulation

- Altanium provides the ability to switch between Phase Angle and Zero Cross power control for each zone
 - Phase Angle: Uniform flow of power reducing time that no energy is being supplied to the heater and ability to limit applied voltage
 - Zero Cross: Switches at 0V eliminating electrical noise that can disturb sensitive equipment on or adjacent to the controller supply lines

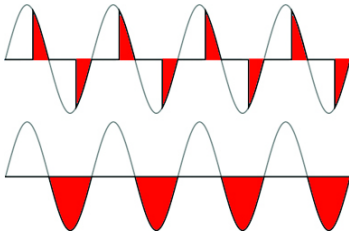

Phase Angle: Fast, uniform power delivery

Zero Cross: Noise free power modulation

- Benefit
 - Optimized power delivery to heaters based on the conditions under which the controller is operating and the heaters thermal response
 - Provides optimal method for extending heater life by applying low voltage to evaporate moisture trapped in the heater body

Wet Heater Low Voltage Bake-out

Phase Angle

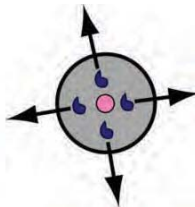
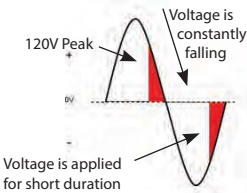

Result

Heat is applied evenly and gradually evaporating moisture while reducing arcing

Zero Cross

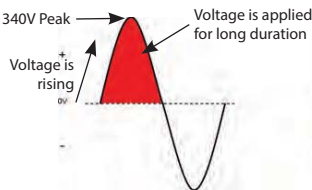

Result

Heat is applied abruptly and for long durations contributing to arcing and premature failure

Key Advantages

Automated Mold Diagnostics

- Altanium is capable of real-time current and voltage measurements providing the ability to test for and identify issues associated with the following items:
 - Supply voltage and current delivery to each heater
 - Thermal response and correct electrical wiring
 - Open, reversed or pinched thermocouples
 - KWH usage per mold
 - Resistance and Wattage measurement for each heater
 - Zone to zone thermal analysis
- Benefit
 - Faster and more accurate diagnosis of mold problems, reducing down time
 - Accurate accounting of power usage and associated cost, better cost per part calculations
 - Soft rewiring of miswired molds, increasing up-time

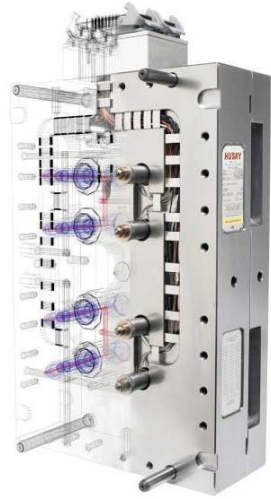

Plastic Leak Detection

- The real-time power deviation monitoring feature provides early warning detection of resin leaks in the gate area and nozzle bore

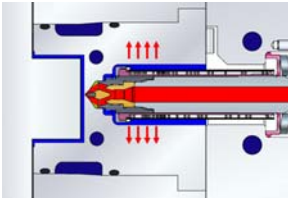

- As plastic fills the nozzle bore, it will increase the heat losses to the gate insert and can unseat or coat the thermocouple connection in the nozzle body
 - This condition will result in a sharp increase in duty cycle to maintain setpoint
 - The Altanium monitors these variations in real-time and triggers a power deviation alarm to alert the user of a possible leak in the gate area or nozzle bore
- Benefit
 - Decreased downtime and operating costs

Key Advantages

Heater Failure Detection

- The real-time current deviation monitoring feature is ideal for detecting a failed heater on a zone configured using multiple heaters in parallel being controlled by a single thermocouple

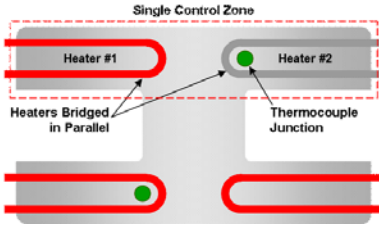

- If one of these heaters were to fail, it would be difficult to detect the specific location of the problem
- Additionally, the functional heater would increase its current draw to compensate for the loss of the second heater and overheat the surrounding steel and degrade the resin
- The Altanium monitors these variations in real-time and triggers a current deviation alarm to alert the user of a possible heater failure in the mold

- Benefit
 - Detect and fix issue before mold is damaged or part quality is compromised downtime

Increased Reliability and Lower Energy Usage

- H-Series control cards are designed to minimize connections and components while providing the lowest cost of ownership by allowing one card type to be used interchangeably with all Altanium controllers
- H-Series control cards employ externally mounted heat-sinks and single-leg switching to the heater that reduces internal cooling fans and the voltage drop across devices, minimizing the amount of energy consumed

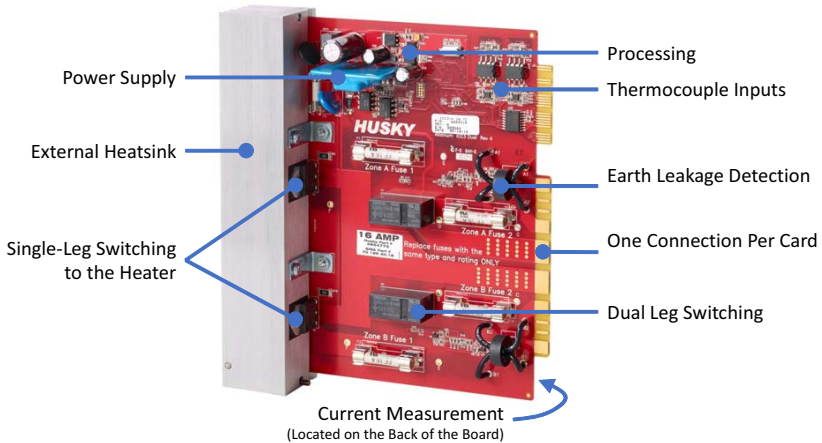

Key Advantages













Mitigate Risk of Mold Damage and Resin Degradation

- Closed-loop digital interlocks between Altanium and the IMM protect the molding process by reducing the need for operator dependent actions



- AT-Temperature Output to IMM:
 - Connects to a signal in the IMM to prevent injecting into a cold hot runner before the mold has reached processing temperature
- PCM Output to IMM:
 - Connects to a signal in the IMM to stop it from cycling if the controller stops heating the mold
- Remote Standby Input from IMM:
 - Connects to a cyclical signal from the IMM to automatically lower the temperature of the hot runner system to prevent resin degradation in the mold if the IMM stops cycling

FTO (Finish to Order)

Mainframe Choices (w/integrated operator interface only)	Power Input Choices	Connector Choices	Card Choices	Cable Choices	Option Choices (Mobile stands and integrated digital I/O package)
 Neo5 6 Slot 1 Bay	200-240V 3Phase 380-415V 3Phase	 Husky standard (24P-2L)	 H-cards 16 amp (2 Zone)	 Husky (2L-1L)	 Neo5 6 Slot 1 Bay
 Neo5 6 Slot 2 Bay		 DME standard (25P-1L)		 HL-cards 16 amp (2 Zone)	
		 Harting 16P standard (16P-2L) <i>HAN E only</i> (380-415V only)		 Harting 16P (2L-2L) <i>HAN E only</i> (380-415V only)	
		 Harting 16P standard (16P-2L) <i>HAN E only</i> (380-415V only)		 Harting 16P (2L-1L) <i>HAN E only</i> (380-415V only)	

FTO Lead-Time

- All FTO controller configurations have a 2 week lead-time from receipt of a clean order
 - Lead-time is subject to maximum quantity limitations for large orders (+5)
- The regions covered by this program are:
 - North America (2 weeks- Milton, VT)
 - Latin America – Excluding Brazil (3 weeks- Milton,VT)
 - EMEA (2 weeks- Dudelange, Luxembourg)
 - Asia (2 weeks- Shenzhen, China)
- There is now an FTO checker in the quote configurator to better identify what configurations are FTO compatible

Dimensions

Neo5

Model Name	Height (H)	Width (W)	Depth (D)
C6-1	407mm 16"	305mm 12"	331mm 13"
C6-2	635mm 25"	305mm 12"	331mm 13"

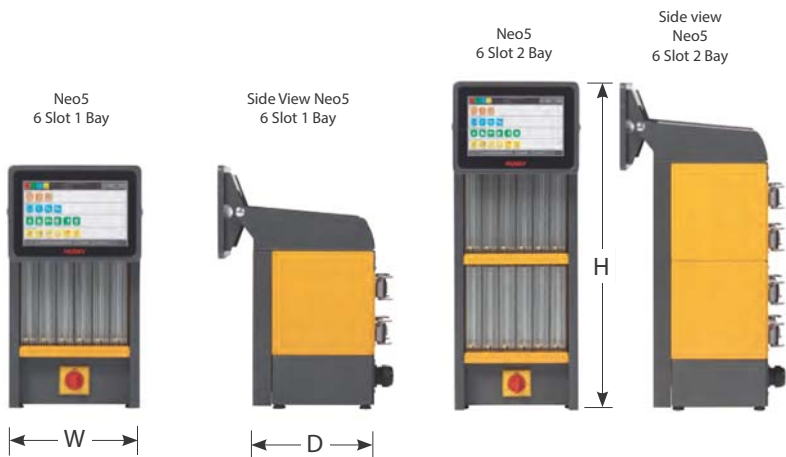

Freestanding

Model Name	Height (H)	Width (W)	Depth (D)
Flat-top 6 Slot 1 Bay	371mm [15"]	305mm [12"]	331mm [13"]
1 Stack (4 Total Bays)	1244mm [49"]	457mm [18"]	558mm [22"]
2 Stack (8 Total Bays)	1244mm [49"]	508mm [20"]	558mm [22"]
3 Stack (12 Total Bays)	1270mm [50"]	762mm [30"]	558mm [22"]
4 Stack (16 Total Bays)	1270mm [50"]	965mm [38"]	558mm [22"]



In this section:

Page

13-1 Interface Feature Comparison

13-10 Digital I/O Options

13-12 Delta5 and Matrix5 Hardware Overview

13-14 Advanced Features

Interface Feature Comparison

Hardware Specifications	Neo5	Delta5	Matrix5
Max Number of Supported Zones	48	128	255
Screen Size	10.1" TFT Color LED	15.6" TFT Color LED	22" TFT Color LED
Screen Resolution	1280x800 WXGA 16:9 Aspect Ratio	1366x768 HD 16:9 Aspect Ratio	1920x1080 Full HD 16:9 Aspect Ratio
Touchscreen Technology	10 Touch PCAP (Projected Capacitive)	10 Touch PCAP (Projected Capacitive)	10 Touch PCAP (Projected Capacitive)
Max Zones Displayed on Screen at One Time	48	128	255

Control Features	Neo5	Delta5	Matrix5
Manual Boost and Standby Modes Lower or raise zone temperatures with touch of a button	✓	✓	✓
Manual Standby/Boost Groups An integral part of the Panes view that allows groups of zones to be placed in standby or boost mode at overlapping intervals	✓	✓	✓
Soft Start One button startup allows all zones to heat evenly reducing stress on mold components and prevents material degradation caused by excessive residency time. Automatically and continuously picks the slow zone to pace the heat up.	✓	✓	✓
Active Reasoning Technology (ART) ART is a proprietary control management technology that provides best in class temperature control	✓	✓	✓
Staging (Startup and Shutdown) Allows zones to be assigned to 4 individual groups to manage the order in which they heat up or shutdown	✓	✓	✓
Multi-cycle wet-heater bake-out (H card only) Provides optimal method for extending heater life by applying low voltage to evaporate moisture trapped in the heater's insulation material	✓	✓	✓
Zero Cross / Phase Angle Control Adjustable per zone to optimize power modulation to heaters based on their response time. Phase angle is critical for proper heater dehumidification.	✓	✓	✓
Auto / Manual Regulation Assign individual zones to run in closed loop (w/TC) control or open loop (set % power output) control modes	✓	✓	✓
Power Limit Provides a settable limit in the amount of power that can be delivered to a zone allowing the controller to run high KW molds on smaller supply services or protect heaters from damage	✓	✓	✓

Interface Feature Comparison

Control Features <i>(continued)</i>	Neo5	Delta5	Matrix5
Auto Power Limiting System calculates full load of connected heater and automatically sets the Power Limiting level to limit the amount of current supplied to the heater thereby preventing the fuse on the card from clearing. This allows lower rated cards, such as the 4z 5A card, to be applied to manifold zones expanding the flexibility to run a controller with a mix of 2 and 4 zone cards on multiple hot runner configuration regardless of the zone order (Sprue→Manifolds→Tips or Tips→Manifolds→Sprue)	✓	✓	✓
At-Temperature Delay Timer Allows a soak period before the IMM can start cycling, ensuring that the material in the mold is at the proper processing temperature. Ideal for valve gated systems because the material in the nozzle may not be at a temperature to allow the stem to break loose preventing potential damage to the stems (Must have At-Temp Output option)	✓	-	-

Zone Recover Features	Neo5	Delta5	Matrix5
Zone Slaving Automatically or manually assign a zone with a failed TC to a zone with similar control characteristics	✓	✓	✓
Automatic Manual Control (AMC) Auto switch over to manual control on TC failure using average power output	✓	✓	✓
Primary Control Mode (PCM) Automatically shut down a zone or the system on any abort condition - system setting triggers digital output to IMM	✓	✓	✓

Security Features	Neo5	Delta5	Matrix5
Role Based Security Profiles Requires a user name and password to log into and use the system. User permissions can be assigned by a specific role to better control who can change process critical zone parameters	✓	✓	✓
Lock Zone Parameters Provides means to lock critical zones to prevent users from changing processing parameters	✓	✓	✓

Calibration Features	Neo5	Delta5	Matrix5
Thermocouple Calibration Calibrate all thermocouple input to the controller on the shop floor directly through the operator interface using an off the shelf calibration device	✓	✓	✓

Interface Feature Comparison

Adjust and Configure Features	Neo5	Delta5	Matrix5
Multi Zone Trimming Incrementally adjust parameters on multiple zones simultaneously	✓	✓	✓
Individually Adjustable Alarm/Abort Limits Allows a different alarm or abort limit to be assigned per zone	✓	✓	✓
Individually adjustable abort limits Allows a different temperature abort limit to be assigned per zone	✓	✓	✓
Zone Naming Assign a custom name to zones for easier identification	✓	✓	✓
Fahrenheit or Celsius Temperature Units Zone temperatures can be displayed in Fahrenheit or Celsius units	✓	✓	✓
Hide Inactive Zones Allows unused zones to be hidden from view eliminating confusion for the operator	✓	✓	✓
Digital I/O Configuration Provides means to manage digital interlocks with the IMM by defining the relay state and assigning channels by function	✓	✓	✓
Mold Setup Storage Save zone parameters by mold name and recall them with the touch of a button	✓ 200+	✓ 200+	✓ 500+
Mold Setup Defaults Provides a means to set custom defaults so that all new mold setups are created using the same base values	✓	✓	✓
Golden recipe overwrite protection The system retains all changes but only make them a permanent part of the loaded mold setup when an authorized user saves the changes	✓	✓	✓
Automatic Setup Recall The system will automatically load the last mold setup when the controller is turned on	✓	✓	✓
Hard shutdown protection Power to the system can be shut off from the main disconnect at anytime without any special software shutdown procedure or sequence. The system persists all changes to the database by clearing the buffer during a built in delay before power is cut to the computer and automatically recalls them on the next power up	✓	✓	✓
J and K Type Thermocouple Support Thermocouple type is selectable in software with security protection. This allows a controller wired with J-Type thermocouples to run a mold configured for K-Type thermocouples with minimal temperature offset errors (It is recommended to always match thermocouple material type between mold, cables and controller)	✓	✓	✓
User Profile Storage and Transfer Save user profile to the system to automatically recall the logged in users language and unit of measure preferences. The saved user profile can be exported to a USB and loaded on another system to save setup time	✓	✓	✓
Customizable Basic and Advanced Modes Fully customizable Basic and Advanced modes that can be assigned to individual operators so they are only using features and functions that are necessary to perform their job.	✓	-	-

Interface Feature Comparison

Card Features	Neo5	Delta5	Matrix5
Integrated all-in-one design Minimizes discrete connections and components which increases reliability and reduces cost of ownership. Each card includes an integrated powersupply, control circuit, thermocouple input circuit and power modulation circuit. In some configurations these circuits are designed as separate cards for up to 4 individual components to stock and maintain	✓	✓	✓
Integrated external heat sink Allows for a lower internal operating temperature which extends the working life of the cards	✓	✓	✓
Safety relay on non-switched leg Allows both heater legs to be isolated when zone is turned off and system is in run mode preventing shock or shorts to ground when servicing the mold	✓	✓	✓
4 zones per card @ 5A each Higher zone density reduces the overall foot print of the controller by as much as 63% saving valuable floor space	✓	✓	✓
2 zones per card @ 16A each Maximizes flexibility to run different molds regardless of the tip/manifold wiring scheme	✓	✓	✓
1 zone card @ 30A Ability to accommodate high current manifold zones commonly used in automotive applications	✓	✓	✓
Run with grounded or ungrounded thermocouples Galvanically Isolated thermocouple inputs provide the flexibility to run any mold without risk of electrical noise interfering with the temperature measurement	✓	✓	✓
Thermocouple Oversampling Sampling the thermocouple every millisecond (1000 times per second) ensures the integrity of the temperature signal which allows the algorithm to execute power changes based on the most accurate data	✓	✓	✓
Fast Power Modulation Rate Once the optimal control algorithm is calculated, the card utilizes a modulation method that provides a uniform flow of power at a rate of 10 milliseconds or less, which greatly reduces the time when no energy is being delivered to the heater, resulting in minimal deviations in temperature or oscillations over time	✓	✓	✓
Fast acting short circuit detection (H card only) Detects shorts in the mold and opens the circuit before the fuse clears providing cost and time savings associated with replacing blown fuses	✓	✓	✓

Interface Feature Comparison

Monitoring Features	Neo5	Delta5	Matrix5
Text View Textual view of all critical zone parameters in the system	✓	✓	✓
Bar Graphs View Graphical view to quickly identify the controller status at a glance	-	✓	✓
Multi-group View Allows zones to be grouped to easily ID them by heater type, material color or resin type	✓	✓	✓
Mold Picture View Allows an image to be assigned to a mold setup that includes zone tiles that identify the area of the picture that is associated with a heating zone in the controller	-	✓	✓
Neo2 View View that mimics the Neo2 zone data screens for greater user familiarity between Altanium products	✓	✓	✓
Current and Voltage Measurement (H card only) System measures and displays the supply voltage and current being delivered to the heaters in real-time. These values can be compared against a historical baseline for troubleshooting and preventative maintenance	✓	✓	✓
Heater Wattage and Resistance Display (H card only) System calculates and displays the heater wattage and resistance for each zone. These values can be compared against a historical baseline for troubleshooting and preventative maintenance	✓	✓	✓
Earth leakage measurement and display (H card only) System continuously measures differential voltage between legs to the heater for detecting earth leakage faults and other types of shorts in the mold that single leg current measurement is not capable of finding. The operator has the option to display the measurement values on the screen or hide them if desired	✓	✓	✓
Supply voltage display (H card only) Provides a graphical layout of the input power configuration connected to the controller. Each phase on the image dynamically displays the voltage measurement with a separate table that includes the measurements for all of the zones in the system grouped by their associated phase. This make it easy to identify a load imbalance or missing phase	✓	✓	✓
View Regulation Allows zones to only read TC so they can monitor steel or water temperatures and assign alarm/abort values to them	✓	✓	✓
Kilowatt/Hour Meter Records the KWH usage for individual mold setups and the system as a whole. Also provides means to calculate energy costs based on a KW per hour charge	-	✓	✓
Audible At-temperature notification Allows the operator to configure the system's horn to be used as an audible notification when the At-Temperature signal goes high by setting it to "chirp" at different frequencies	✓	✓	✓
No Heater Alarm Provides instantaneous feedback that a heater has failed or is no longer connected to the circuit by continuously monitoring the current draw of all heaters to ensure it is above the user defined "no heater detection limit" for >10 Seconds.	✓	✓	✓
LED Backlight Sleep Mode Allows the operator to configure the system to shut off the backlight of the monitor after a user defined period of no interaction to save energy and increase screen longevity	-	✓	✓

Interface Feature Comparison

Auditing Features	Neo5	Delta5	Matrix5
Blown Fuse Detection Detects when a fuse clears while identifying the associated card where the fuse is located	✓	✓	✓
Open, Pinched or Reversed T/C Detection System is capable of detecting different types of TC errors on multiple zones at one time	✓	✓	✓
Ground Fault Detection (H card only) Runs a ground fault check before power is applied to the heaters to prevent damage to the HR and hazardous electrical conditions for the operator	✓	✓	✓
Log Changes Automatically stores all zone parameter changes by mold setup name with a time/date stamp for easy ID and recall	✓	✓	✓
Error Data Collection Automatically stores all errors by mold setup name with a time/date stamp for easy ID and recall	✓	✓	✓
Data Logging Provides means to record and store process data based on a set time interval	✓	✓	✓
Real Time Zone Charting Allows a user to chart multiple zones in individual viewing panes in real time to compare performance or detect issues in real-time. Also allows multiple parameters from individual zones to be selected for comparison such as: current, power output %, actual temperature and voltage	✓	✓	✓
Current Deviation Provides means to identify an individual heater failure on zones that utilize multiple heaters tied to a single TC	✓	✓	✓
Power Deviation (Resin Leak Detection) Monitors and detects deviations in the power being delivered to a heater for identifying resin leaks in the gate area and nozzle bore	✓	✓	✓
Print-to-file Print screen shots or system reports directly to a USB disk	✓	✓	✓
Continuous Printing Copy zone data reports directly to a USB disk based on a user specified frequency and duration. This can be vital for trouble shooting issues or keeping a historical record of the process	✓	✓	✓

Connectivity and Communication Features	Neo5	Delta5	Matrix5
Online help Access and view the user guide directly from the operator interface. The user guide is also downloadable for printing a hard copy	-	✓	✓
Multi-language support Change screen languages with a touch of a button.	✓-11	✓-11	✓-11
Store PDF files Import and view PDF documents in the system including user references or instructions	-	✓	✓
Store BMP, JPG and PNG images Import and view multiple image file types for user reference or assigning to mold picture view or notes	✓	✓	✓
Standard Digital I/O (Included w/purchase of display) Digital inputs and outputs provide interlocks between the controller and IMM preventing damage to the mold or process	-	✓ - Up to 4 any combo of In or Out	
Remote standby input from injection mold machine This is digital input to the controller from a cyclical output signal on the injection molding machine that when activated automatically lowers the temperature of the hot runner system to prevent resin degradation if the molding process stops for an extended period of time. It can also be configured with a delay timer the will inhibit the controller from going into standby mode until the timer expires	✓	✓	✓
Networking (push/pull files to a network share) Push an pull files to and from the controller over a network	✓	✓	✓

Interface Feature Comparison

Connectivity and Communication Features	Neo5	Delta5	Matrix5
Networking (Automatically write process data files to a network share) Automatically write process variables as individual CSV files to a network file share based on a user definable frequency	✓	✓	✓
Wireless Network Connection Connect to a network wirelessly using a Netgear A6200 USB Wi-Fi adapter (dongle). This device is available for purchase from Husky or a third-party supplier	-	✓	✓

Diagnostic Features	Neo5	Delta5	Matrix5
Mold Diagnostics Routine Automatically test all heaters, sensors and wiring in the mold to quickly ID issues or validate mold before running production	✓	✓	✓
Thermodynamic Mold Analysis System graphs temperature profile of all zones in a single view to quickly ID any slow or non-responsive zones	✓	✓	✓
X-talk System records thermal isolation between zones to ID issues with TC placement	✓	✓	✓
Detect and Rewire a Miswired Mold Enables controller to detect a miswired mold and rewire the TC through the software	✓	✓	✓
Mold Test Comparisons Allows individual mold tests to be stored and compared against a baseline to easily identify changes in key electrical measurements for preventative maintenance purposes	✓	-	-
Export Mold Test Data Save mold test data to a USB disk so it can be stored on a PC or used to create custom reports in Excel	✓	✓	✓
Card Layout A virtual view of the controller to easily associate zones to a card location and ID a blown fuse or other components at the card level	-	✓	✓
Heater Watt Conversion Based on Supply Voltage Calculates the adjusted wattage of the heaters based on the supply voltage. Useful for determining if a heater is of sufficient size to reach a given setpoint when operating on a voltage lower than what it was designed for	-	✓	✓
Circuit Test (H card only) System performs a series of test for all connected heater circuits on startup by applying low power to detect the following faults: <ul style="list-style-type: none"> • Leakage: A low current short to ground that typically occurs when moisture is absorbed by a heater's insulation material • Power to Thermocouple: Occurs when a cable plugged into the thermocouple connector on the mold is attached to the power output of the controller • Short Circuit: Occurs when current travels along an unintended path as the result of a wiring error across the heater outputs, a pair of frayed conductors or a pinched wire • Open Circuit: Occurs when a conductor is broken or comes loose and no current flows through the circuit it is associated with • Wrong Heater: This is a case when the heater exceeds the capacity of the zone it is connected to in the controller. The system can be configured to automatically set the Power Limit level <ul style="list-style-type: none"> - This feature is critical to minimizing the risk of damage to the controller or hot runner system 	✓	✓	✓
Circuit overload detection During circuit test the system will detect and alert the operator if a heater exceeds the capacity of the zone it is connected to in the controller. The system can be configured to automatically set the Power Limit level to run the heater if desired	✓	✓	✓

Interface Feature Comparison

Diagnostic Features	Neo5	Delta5	Matrix5
Power output of controller connected to thermocouple in mold detection During circuit test the system will detect when a cable plugged into the thermocouple connector on the mold is attached to the power output of the controller. The system will stop power output and alert the operator before any damage occurs to the thermocouple wire housing or junction point	✓	✓	✓
Troubleshooting Guide (H card only) If a fault is detected during the circuit test a, Problem and Solutions dialog popup is triggered that provides access to an on-screen troubleshooting guide by selecting one of the potential solutions. The Troubleshooting guide displays a graphic with the troubleshooting steps to assist the operator in fixing the reported problem	-	✓	✓

Optional Features	Neo5	Delta5	Matrix5
Integrated Digital I/O Option Integrated digital I/O channels means that the controller incorporates the supporting hardware inside the display base without the need for a separate I/O box	Limited 4IN, 4OUT	✓ 16IN, 16OUT	✓ 16IN, 16OUT
Remote Load Option Allows a different binary address to be assigned up to 1023 individual mold setups providing the means to remotely load them based on corresponding digital inputs from the IMM or mold	-	✓	✓
Part Counting Option Provides means to count parts based on cavity utilization against a set limit that when reached triggers an output signal to change the part storage container	-	✓	✓
Link Option Connect up to 4 individual mainframes to a single operator interface allowing multiple smaller controllers to perform the job of a larger controller with the added advantage of being able to break them apart once the job has been completed	-	✓	✓
Dashboard Option Provides remote access to the controller for monitoring processing data using the Altanium Dashboard application on any computer that supports an internet browser (IE9, Chrome, Firefox or Safari)	-	✓	✓
UltraSync-E Gen2 Option (Low Cav = or <64 drops) UltraSync E servo control is integrated into the operator interface eliminating the need for a separate display and providing the means to configure motion and recall profiles directly from the HR controller screen	-	✓	✓
UltraSync-E Gen2 Option (High Cav >64 drops) Same advantages as above, but optimized control for hot runner systems that have more than 64 cavities	-	-	✓
UltraSync-E Gen2 Option (Dual UltraSync-E Control) Same advantages as above, but designed with control for two separate UltraSync-E hot runner systems integrated into the operator interface (Ideal for stack/back-to-back mold designs)	-	-	✓
Altanium Servo Control Integrated control for up to 6 servo axes (motors) for controlling motion in the mold such as core pulls, stripper plates and coining operations	-	-	✓
SPI Option SPI is a protocol for enabling the controller to communicate with a compatible IMM or with the Priamus Fill & Cool and ComoNeo systems	-	✓	✓

Interface Feature Comparison

Optional Features (Continued)	Neo5	Delta5	Matrix5
Modbus Interface (Read Only) The Modbus Read Only interface allows the Altanium to communicate over a standard Modbus network as a server. It supports commands using Modbus TCP over Ethernet. The read only version only allows process variables to be read from the controller for monitoring purposes only	✓	-	-
Modbus Interface (Read/Write) The Modbus Read/Write interface allows the Altanium to communicate over a standard Modbus network as a server. It supports commands using Modbus TCP over Ethernet. The read/write version allows process variables to be read from the controller for monitoring purposes and written to the controller for as a means of remote control.	✓	-	-
Shotscope NX Interface Provides a means to connect to and push processing data to a SSNX process and production monitoring system. This is also a solution to exchange Altanium process data with a third-party process monitoring system, over OPC-UA, using the SSNX OPC-UA module	-	✓	✓
Hylectric RS422 Machine Interface (Machine option #C6040) The RS422 machine interface is a Husky protocol that allows the Altanium controller to communicate to a HyCAP machine without the need for an I/O Box. It also supports remotely loading mold setups on the controller and the automated color change feature	-	✓	✓
HyperSync/HyCAP4 Real-Time Ethernet Interface (Machine option #C6041) The communication between the machine and Altanium controller is done over Ethernet. This interface supports all of the RS422 functionality above and allows the Altanium screens to be displayed directly on the Polaris HMI for remote control of the hot runner controller	-	✓	✓
VNC Server Virtual Network Computing server is a screen sharing technology that allows remote access and control of another computer. It works by transmitting screen data and all touchscreen movements from the Altanium Mold Controller to a client computer such as an injection molding machine's operator interface	-	✓	✓
OPC UA Server The OPC UA server allows the Altanium to interface with data collection and process control systems for the collection of mold specific data such as cavity utilization and energy consumption so it can be made available for upstream analysis	-	✓	✓
Euomap 82.2 Interface The Euomap 82.2 interface allows the exchange of process variables, messages, and low-level control between Altanium and a Euomap 82.2 enabled IMM	-	✓	✓

Digital I/O Options

Signal Type	Operator Interface	Function	Description
Digital Input (From IMM)	All	Remote Standby Input	Places all zones that have a Remote Standby setpoint into Standby mode (Lower setpoint) whenever this input signal is activated <i>NOTE: This should be connected to a cyclical signal (Signal goes high to low during each injection cycle)</i>
	All	Remote Boost Input	Places all zones that have a Remote Boost setpoint into the Boost mode (Higher setpoint) whenever this input signal is activated <i>NOTE: This should be connected to a cyclical signal (Signal goes high to low during each injection cycle)</i>
	All	Remote Start Input	Places the system in start mode whenever this signal is remotely activated. This state will remain until the STOP key is selected or Remote Stop is activated
	All	Remote Stop Input	Places the system in stop mode whenever this signal is remotely activated. This state will remain until the START key is selected or Remote Start is activated. <i>NOTE: The system cannot be started when this input is active</i>
	Delta5/ Matrix5	Manual Boost Input	Places all zones that have a Manual Boost setpoint set into Boost mode (Higher setpoint) whenever this input signal is activated. <i>NOTE: This is the same as if an operator touched the boost key in the operator interface</i>
	Delta5/ Matrix5	Cooling Lines Not Enabled Input	Forces a warning message "Mold Cooling Lines are not Enabled" on the screen until the signal has been deactivated. This signal is intended to come from a mold temperature controller. <i>NOTE: Anytime the mold temperature controller is turned off (Input signal active), the warning message will be displayed</i>
	Delta5/ Matrix5	Cycle Input	Provides a start or end of cycle signal from the injection molding machine. This input can be configured as the trigger for logging process data on Altanium systems configured for hot runner temperature control. <i>NOTE: This should be connected to a cyclical signal (Signal goes high to low during each injection cycle)</i>

Digital I/O Options *(Continued)*

Signal Type	Operator Interface	Function	Description
Digital Output (To IMM)	All	At Temperature Output	Activated ONLY when all zones are above their Under-Temperature alarm limit. This state will remain until any zone drops below its Under Temperature alarm limit or the controller is put into Stop mode
	All	PCM Relay Output	Activated when an Abort condition occurs, and the PCM setting in the Quick Set screen is set to System. This state will remain until the alarm condition is CLEARED or RESET
	All	Alarm Relay Output	Activated when an Alarm or Abort condition occurs. This state will remain until the alarm condition is CLEARED or RESET
	All	Run Light Output	Activated whenever the START button is pressed. This state will remain until the system is placed in STOP mode
	Delta5/ Matrix5	Remote Standby Output	Activated when controller has received the Remote Standby input signal
	Delta5/ Matrix5	At Boost Temp Output	Activated ONLY when all zones with a Remote Boost setpoint are above their under-temperature alarm limit while in BOOST mode. This state will remain until any zone drops below its under temperature alarm limit or the controller is put into Stop mode <i>NOTE: If any or all zones go above the over temperature alarm limit the state will remain</i>
	Delta5/ Matrix5	Max Temp Error Output	Activated when any zone exceeds the Over Maximum Temperature limit
	Delta5/ Matrix5	Mold Cooling Enabled Output	Activated when all temperatures are greater than the Mold Cooling Enabled Limit. <i>NOTE: All temperatures must be equal to or lower than the Mold Cooling Enabled Limit before the signal is deactivated once the system is in STOP mode</i>
	Delta5/ Matrix5	At Standby Temperature Output	Activated ONLY when all zones with a Remote Standby setpoint are above their under-temperature alarm limit while in Standby mode. This state will remain until any zone drops below its under temperature alarm limit or the controller is put into Stop mode <i>NOTE: If any or all zones go above the over temperature alarm limit the state will remain</i>
	Delta5/ Matrix5	Comm Error Output	Activated if the controller stops communicating with any of the Control Cards. This state will remain until communications are restored
	Delta5/ Matrix5	Process Outside Limits Output	Activated if any critical process parameter violates its threshold setting <i>NOTE: The threshold setting is in the Process Limits screen</i>
	Delta5/ Matrix5	Boost Active Output	Activated when the controller is in Boost mode. This state will remain high (Regardless if the Boost mode has been canceled or expired) until all zones are under the upper alarm limit. This will ensure that all parts molded within this timeframe will be declared scrap and diverted to a scrap container <i>NOTE: The feature applies to Manual and Remote Boost modes</i>

Delta5 and Matrix5 Hardware Overview

Design Overview



Feature	Delta3/ Matrix2	Delta5/ Matrix5	5 Series Advantage
Screen Size	12.1" 1024x768 19" 1280x1024	15.6" 1366x768 HD 22" 1920x1080 Full HD	33% More viewing area
Boot Time	2:32 and 3:50 (mm:ss)	1:24 and 1:05 (mm:ss)	61% Less time consumed
Screen Switching Speed	119 & 490 (Images rendered/ second)	324 and 500 (Images rendered/ second)	26% Faster navigation
Increased Maximum Setpoint Limit	500°C (932°F)	600°C (1112°F)	Apply to temperature control application outside of HR
Current Deviation	-	✓	Better heater failure detection
No Heater Alarm	-	✓	Better heater failure detection
LCD Backlight Sleep Mode	-	✓	Less energy consumption











Delta5 and Matrix5 Hardware Overview

Feature	Delta3/ Matrix2	Delta5/ Matrix5	5 Series Advantage
Cycle Input Signal	-	✓	Tie data collection to IMM cycle
Auto Power Limiting	-	✓	Expanded use of 4z card
VNC Server	-	✓	Share Altanium screens on IMM or remote computer
OPC UA Server	-	✓	Enterprise data exchange solution (IIoT and Industry 4.0)
Euromap 82.2 Interface	-	✓	Industry standard IMM interface for low level control and data exchange
Wireless Connectivity	-	✓	Additional method to gain access to the controller when a wired network connection is not available
User Profile Import/ Export	-	✓	Increased ease of use
Automated Data Transfer	-	✓	Simplified method for exchanging Altanium process data over a network

Advanced Features

Altanium is a highly integrated control platform for hot runner and mold control

- Altanium mold controllers offer the industry's most integrated platform for single-point access to the highly accurate and straightforward operation of temperature, servo, and valve gate control

Control Technology Compatibility Chart						
		Hot Runner Control	Altanium Servo Control	UltraSync-E Control	Valve Gate Sequencer Control	Individual Servo Valve Gate Control
	Hot Runner Control	-	✓ Matrix5	✓ Delta5/Matrix5	✓ Delta5/Matrix5	✓ Matrix5
	UltraSync-E Control	✓ Delta5/Matrix5	✓ Matrix5	-	-	✓ Matrix5
	Valve Gate Sequencer Control	✓ Delta5/Matrix5	-	-	-	-
	Altanium Servo Control	✓ Matrix5	-	✓ Matrix5	-	✓ Matrix5
	Individual Servo Valve Gate Control	✓ Matrix5	✓ Matrix5	✓ Matrix5	-	-

Advanced Features

Data Exchange Interfaces

- Automatic File Transfer to Network File Share
 - Automatic file transfer is a standard feature on all Altanium operator interfaces. It provides the means to set up an automated way to transfer a .csv file containing temperature control process variables to a file share on a network based on a defined time interval. This feature is the most basic data collection method available for Altanium.
- OPC UA Server
 - The OPC UA Server interface is a paid option available with the Delta5 and Matrix5 operator interfaces. It provides a means to interface with a customer's process or production monitoring systems utilizing readily available third-party client applications that support the OPC UA data exchange standard. This interface is based on the Euromap 82.2 standard and allows the customer to read, write and collect data using an Industry 4.0 solution.
- Euromap 82.2 (EM82.2) Injection Molding Machine Interface
 - The EM82.2 interface is a paid option available with the Delta5 and Matrix5 operator interfaces. It provides a means to interface with any injection molding machine that supports the Euromap 82.2 interface for hot runner controllers. Based on the OPC UA data exchange standard, the customer can read, write and collect data using an Industry 4.0 solution.
- SPI Injection Molding Machine Interface
 - SPI is a paid option available with the Delta5 and Matrix5 operator interfaces. It provides a means to interface with any injection molding machine that supports the Society of Plastics Industry (SPI) interface for hot runner controllers. SPI is an older, dated interface used primarily for interfacing with the Priamus Fill & Cool and Kistler Como or ComoNeo systems.
- Shotscope NX (SSNX) Interface
 - The SSNX interface is a paid option available with the Delta5 and Matrix5 operator interfaces and provides a means to interface with the Husky Shotscope NX process and production monitoring system. This interface only applies to customers that have Shotscope NX systems installed in their plant.
- TeamViewer Interface
 - TeamViewer is a standard interface available on all Delta5 and Matrix5 operator interfaces, regardless of the configured control technology (HRC, US-E, ASC, VGS, ISVG). It provides a means for Husky service personnel to access an Altanium controller for remote troubleshooting purposes. This interface can be used by the customer, but only when directed to do so.
- Virtual Network Computing (VNC) Server
 - VNC is a paid option available with the Delta5 and Matrix5 operator interfaces. It provides a means to share and control the Altanium screens with a client, such as an injection molding machine's operator interface or another remote computer. This technology is intended for remote control only when there is a clear line of sight to the Altanium from the IMM operator interface or remote computer.

Advanced Features

Data Exchange Interfaces

- Modbus TCP Server
 - The Modbus TCP Server is a paid option, available with the Neo5 operator interface, and provides a means to communicate with a host computer using the Modbus protocol over Ethernet. The customer is responsible for implementing the Modbus client application per the Altanium Neo5 Modbus Interface design document. This solution provides the ability to read, write and collect data from the Neo5 by using a Modbus client device.
- Wired Network Connection
 - There is a wired network connection available on the Neo5, Delta5 and Matrix5 operator interfaces as standard. Interfacing to the following options requires this connection:
 - Automatic file transfer to network file share
 - OPC UA Server
 - Euromap 82.2 Injection Molding Machine Interface
 - Shotscope NX Interface
 - Team Viewer Remote Support Interface
 - Virtual Network Computing (VNC) Server
 - Modbus TCP Server
- Wireless Network Connection
 - The Delta5 and Matrix5 operator interfaces support connecting to a wireless network as standard. This connection requires the installation of a Netgear A6200 Wi-Fi USB Adapter. The adapter is available for purchase through Husky or from a third-party supplier. The options listed under Wired Network Connection can also be accessed using this wireless connection.

Data Exchange Interface Type	Data Collection	Read Data	Write Data	Remote Support	Neo5	Delta5	Matrix5
Automatic File Transfer to Network File Share	✓	-	-	-	✓	✓	✓
OPC UA Server	✓	✓	✓	-	-	✓	✓
Shotscope NX Interface	✓	✓	-	-	-	✓	✓
TeamViewer Interface	-	-	-	✓	-	✓	✓
Virtual Network Computing (VNC) Server	-	-	✓	-	-	✓	✓
Euromap 82.2 Injection Molding Machine Interface	✓	✓	✓	-	-	✓	✓
SPI Injection Molding Machine Interface	✓	✓	✓	-	-	✓	✓
Modbus TCP Server	✓	✓	✓	-	✓	-	-
Wired Network Connection	-	-	-	-	✓	✓	✓
Wireless Network Connection	-	-	-	-	-	✓	✓

In this section:

Page

14-1 H-Series Card Configurations

14-4 H-Series Card Key Improvements

14-5 H-Series Card Feature Comparison

H-Series Card Configurations

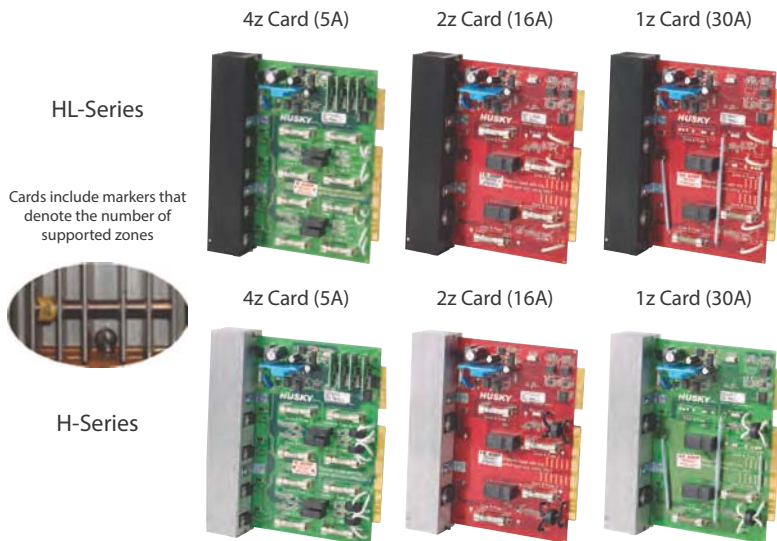

Please note that all cards have now been switched over to red

- Available zone configurations:
 - 4 zones @ 5A each (Optimized for tip zones)
 - 2 zones @ 16A each (Optimized for manifold zones)
 - 1 zone @ 30A each (Optimized for high wattage manifold zones)
- Models:
 - HL-Series
 - Equivalent to ICC2 XL-Series, economical solution w/voltage but no current or ground fault measurement
 - H-Series
 - Equivalent to ICC2 X-Series, full-featured with current, ground fault and voltage measurement
- Backplane
 - Accepts any combination of H/HL-Series cards
 - Max zones per backplane: 24z (6 x 4z card)
 - Phase balanced design
 - Power is better distributed across slots to reduce input supply requirements
 - Not compatible with ICC2 cards
 - Different keying and spacing on connector
 - Communication and addressing structure is different
 - Same physical size and mounting as ICC2 backplane
 - Possible to retrofit ICC2 mainframe for use with H-Series cards



H-Series Card Configurations

- On startup, H-Series cards perform a heater circuit test on each zone simultaneously before full power is applied to minimize risk of damage to the controller or hot runner system
- This test is critical for detecting the following heater circuit faults:
 - Leakage: A low current short to ground that typically occurs when moisture is absorbed by a heater's insulation material
 - Power to Thermocouple: Occurs when a cable plugged into the thermocouple connector on the mold is attached to the power output of the controller
 - Short Circuit: Occurs when current travels along an unintended path as the result of a wiring error across the heater outputs, a pair of frayed conductors or a pinched wire
 - Open Circuit: Occurs when a conductor is broken or comes loose and no current flows through the circuit it is associated with
 - Wrong Heater: This is a case when the heater exceeds the capacity of the zone it is connected to in the controller. The system can be configured to automatically set the Power Limit level

This test provides in under 17 seconds an automated comprehensive diagnostics of all zones in the mold each time the controller is started reducing the need for conducting more time consuming sequential thermocouple and heater checks and operator dependent actions.

H-Series Card — Circuit Diagram		
<p>Legend: I_T = Amperage Current Sensor I_L = Leakage Current Sensor E = Voltage Sensor</p>		
Circuit Test	Test Description	Example Fault
Level 1	Low level leakage check, wet heater bake-out evaluation and power to thermocouple fault assessment	

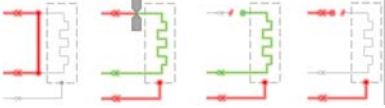
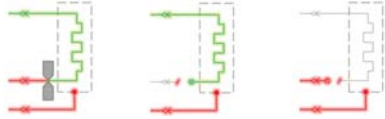
H-Series Card Configurations

Circuit Test	Test Description	Example Fault
Level 2	Leakage check and short circuit evaluation of triac-side faults	 <p>Short Across Source before heater Short Triac Side Pinched Triac Side Load Pulled out and Shorted Triac Side Source Pulled out and Shorted</p>
Level 3	Leakage check and short circuit evaluation of relay-side faults	 <p>Short Relay Side Pinched Relay side Load Pulled out and Shorted Relay Side Source Pulled out and Shorted</p>
Level 4	Line-to-line check for over-sized heaters	<p>3840W 4320W</p> 

H-Series Card Key Improvements

H-Series 2z Card (16A per Zone)



Circuit
Measurement
on Backside

- 1 Independent mechanical relays for each zone
 - Allows both legs to be isolated when zone is turned off in run mode
- 2 Differential current measurement per zone
 - Improved ground fault and short circuit detection
- 3 Redesigned voltage and current measurement circuits
 - More accurate voltage and current readings
- 4 Upgraded processor and CANbus transceiver
 - More robust communications with HMI
- 5 Better resolution on ADC and CJC sensor reposition
 - More accurate thermocouple measurement
- 6 Fully isolated T/C channels
 - Greater immunity to electrical noise
- 7 Fast acting short circuit detection built into processor *
 - Detect a short and open circuit before fuse clears

* Effectiveness determined by the configuration of the supply voltage and region where operating

** Effectiveness determined by the length of thermocouple wire in hot runner system

- Benefit
 - Better troubleshooting and fault mitigation capabilities
 - Detect a greater range of fault conditions by measuring both current and earth leakage
 - Detect a short and stop power output before the fuse clears using the fast acting short circuit detection function*
 - Detect when power is applied to a thermocouple circuit in hot runner and stop power before any damage occurs to the thermocouple wire housing**

H-Series Card Feature Comparison

Functions / Features	Cards		Benefit
	HL	H	
Integrated design with external heat sink	✓	✓	Allows for a lower internal operating temperature which extends the working life of the cards
Active Reasoning Technology (ART)	✓	✓	Provides accurate and repeatable temperature control that minimizes deviations from setpoint allowing the opportunity to reduce cycle times and energy consumption
Integrated all-in-one design	✓	✓	Minimizes discrete connections and components which increases reliability and reduces maintenance costs
4 zones per card @ 5A each	✓	✓	Higher zone density reduces the overall foot print of the controller by as much as 25% saving valuable floor space
4 zones per card @ 5A each	✓	✓	Maximizes flexibility to run different molds regardless of the tip/manifold wiring scheme
4 zones per card @ 5A each	✓	✓	Ideal for high current manifold zones commonly used in automotive and other large part applications
Run with grounded or ungrounded thermocouples	✓	✓	Isolated thermocouple inputs provide the flexibility to run any mold without risk of electrical noise interfering with the temperature measurement
Safety relay on non-switched leg	✓	✓	Allows both heater legs to be isolated when zone is turned off and system is in run mode preventing electrical shock or shorts to ground when servicing the mold
Thermocouple slaving (auto and manual)	✓	✓	Allows automatic on-the-fly recovery of failed thermocouples based on following the power output of a similar zone, eliminating any downtime
Zero-Cross or Phase Angle power output control	✓	✓	Uniform flow of power reducing time that no energy is being supplied to the heater and ability to limit applied voltage
Card interchangeability	✓	✓	Reduced number of components to stock and maintain contributes to lower maintenance costs
Automated mold diagnostics	✓	✓	Quickly and accurately diagnose issues in the mold without the need for additional tools, limiting downtime and associated costs
On screen board diagnostics (Delta5 and Matrix5 only)	✓	✓	Identifies the exact location of failed card or component, such as a fuse or switching device, reducing downtime and maintenance costs
Power deviation alarm for plastic leak detection	✓	✓	Real-time power deviation monitoring provides early warning detection of resin leaks in the gate area of the mold
Softstart for even thermal expansion on heat up	✓	✓	Contributes to longer mold component life, reduced material degradation due to excessive residency time and maximizes energy efficiency
Multi-cycle wet-heater bake-out	✓	✓	Provides optimal method for extending heater life by applying low voltage to evaporate moisture trapped in the heater's insulation material

H-Series Card Feature Comparison

Functions / Features	Cards		Benefit
	HL	H	
Real-time voltage measurement	✓	✓	Helps in diagnosing heating issues in the mold and problems associated with the mains supply to the controller
Real-time amperage measurement	-	✓	Helps in diagnosing problems in the mold, calculating power consumption and preemptive heater failure
Real-time wattage and ohm calculations	-	✓	Helps in diagnosing problems in the mold, determining heater size for replacement and calculating power consumption
Real-time earth leakage measurement	-	✓	Helps to detect earth leakage faults and other types of shorts in the mold that single leg current measurement is not capable of finding
Fast acting short circuit detection	-	✓	Detects shorts in the mold and opens the circuit before the fuse clears providing cost and time savings associated with replacing blown fuses
Power to thermocouple detection	-	✓	Detects when power is mistakenly applied to a thermocouple circuit and shuts power off before the thermocouple wire or hot runner is damaged
Current deviation alarm for failed heater detection	-	✓	Real-time current deviation monitoring provides early warning detection of a failed heater on a single zone running multiple heaters using a single thermocouple



HL-Series 2z @ 16A Card



H-Series 2z @ 16A Card

In this section:

Page

15-1 Standard Cable Packages



15-15 Non-Standard Cable Package Definitions



Standard Cable Packages

Husky Standard Power and Thermocouple Cables					
Power: 24M – 2L/24F – 1L T/C: 24F – 2L/24M – 1L					
Reference Image	Controller Wiring				
Controller Connectors	Zone	Female		Male	
		Power	Power	T/C (+)White	T/C (-) Red
T/C					
PWR					
Cable Connectors	1	1	13	1	13
	2	2	14	2	14
	3	3	15	3	15
	4	4	16	4	16
	5	5	17	5	17
	6	6	18	6	18
	7	7	19	7	19
	8	8	20	8	20
	9	9	21	9	21
	10	10	22	10	22
	11	11	23	11	23
	12	12	24	12	24



Husky Standard Power and Thermocouple Cables					
Power: 24M – 2L/24F – 2L T/C: 24F – 2L/24M – 2L					
Reference Image	Controller Wiring				
Controller Connectors	Zone	Female		Male	
		Power	Power	T/C (+)White	T/C (-) Red
T/C					
PWR					
Cable Connectors	1	1	13	1	13
	2	2	14	2	14
	3	3	15	3	15
	4	4	16	4	16
	5	5	17	5	17
	6	6	18	6	18
	7	7	19	7	19
	8	8	20	8	20
	9	9	21	9	21
	10	10	22	10	22
	11	11	23	11	23
	12	12	24	12	24

Standard Cable Packages

DME Standard Power and Thermocouple Cables						
Power: 25M – 1L/25F – 1L T/C: 25F – 1L/24F – 1L						
Reference Image		Controller Wiring				
Controller Connectors T/C  PWR 		Zone	Female		Male	
			Power	Power	T/C (+)White	T/C (-) Red
Cable Connectors  T/C - Controller T/C-Mold PWR - Controller PWR-Mold		1	1A	2A	1	13
		2	3A	4A	2	14
		3	5A	6A	3	15
		4	7A	8A	4	16
		5	2B	3B	5	17
		6	4B	5B	6	18
		7	6B	7B	7	19
		8	1C	2C	8	20
		9	3C	4C	9	21
		10	5C	6C	10	22
		11	7C	8C	11	23
		12	9A	9C	12	24

Harting Standard Power and Thermocouple Cables						
Power: 16M – 2L/16F – 1L T/C: 16F – 2L/16M – 1L (HAN-E)						
Reference Image		Controller Wiring				
Controller Connectors (HAN-E) T/C  PWR 		Zone	Female		Male	
			Power	Power	T/C (+)White	T/C (-) Red
Cable Connectors (HAN-E)  PWR-Mold PWR - Controller T/C - Controller T/C-Mold		1	1	9	1	9
		2	2	10	2	10
		3	3	11	3	11
		4	4	12	4	12
		5	5	13	5	13
		6	6	14	6	14
		7	7	15	7	15
		8	8	16	8	16

Standard Cable Packages

Harting Standard Power and Thermocouple Cables					
Power: 16M – 2L/16F – 2L T/C: 16F – 2L/16M – 2L (HAN-E)					
Reference Image	Controller Wiring				
Controller Connectors (HAN-E) 	Zone	Female		Male	
		Power	Power	T/C (+)White	T/C (-) Red
	1	1	9	1	9
	2	2	10	2	10
Cable Connectors (HAN-E) 	3	3	11	3	11
	4	4	12	4	12
	5	5	13	5	13
	6	6	14	6	14
	7	7	15	7	15
	8	8	16	8	16

Standard Cable Packages

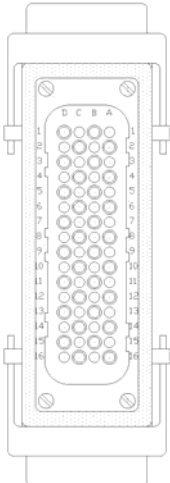
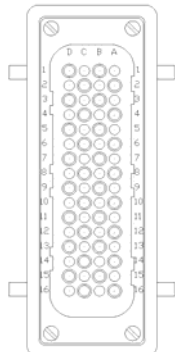
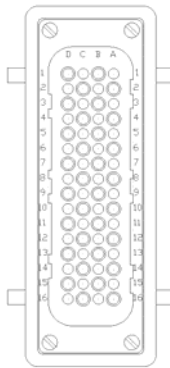
Husky Standard Harting 32z Power Cable					
Cable Description: PWR CBL 32Z XX.XM* (H64M-2L/H64F-2L) *Available in 4.5, 6, 7.5 and 9 meter lengths					
Connector on Controller (Han D 64P Female 2 Latch)	Cable – Controller End (Han D 64P Male 2 Latch)	Cable – Mold End (Han D 64P Female 2 Latch)	Zone #	Pin-Out	
			1	1A	1B
			2	2A	2B
			3	3A	3B
			4	4A	4B
			5	5A	5B
			6	6	6B
			7	7A	7B
			8	8A	8B
			9	9A	9B
			10	10A	10B
			11	11A	11B
			12	12A	12B
			13	13A	13B
			14	14A	14B
			15	15A	15B
			16	16A	16B
			17	1C	1D
			18	2C	2D
			19	3C	3D
			20	4C	4D
			21	5C	5D
			22	6C	6D
			23	7C	7D
			24	8C	8D
			25	9C	9D
			26	10C	10D
			27	11C	11D
			28	12C	12D
			29	13C	13D
			30	14C	14D
			31	15C	15D
			32	16C	16D

Standard Cable Packages

Husky Standard Harting 32z Thermocouple Cable					
Cable Description: TC CBL 32Z J XX.XM* (H64F-2L/H64M-2L) *available in 4.5 meter length					
Connector on Controller (Han D 64P Male 2 Latch)	Cable – Controller End (Han D 64P Female 2 Latch)	Cable – Mold End (Han D 64P Male 2 Latch)	Zone #	Pin-Out	
				(+)	(-)
			1	1A	1B
			2	2A	2B
			3	3A	3B
			4	4A	4B
			5	5A	5B
			6	6	6B
			7	7A	7B
			8	8A	8B
			9	9A	9B
			10	10A	10B
			11	11A	11B
			12	12A	12B
			13	13A	13B
			14	14A	14B
			15	15A	15B
			16	16A	16B
			17	1C	1D
			18	2C	2D
			19	3C	3D
			20	4C	4D
			21	5C	5D
			22	6C	6D
			23	7C	7D
			24	8C	8D
			25	9C	9D
			26	10C	10D
			27	11C	11D
			28	12C	12D
			29	13C	13D
			30	14C	14D
			31	15C	15D
			32	16C	16D

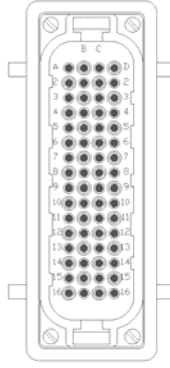
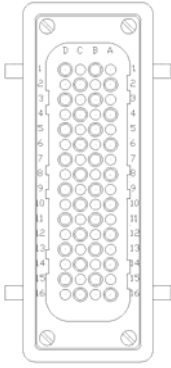
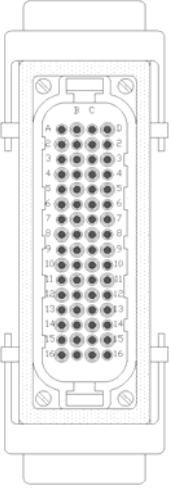

Standard Cable Packages

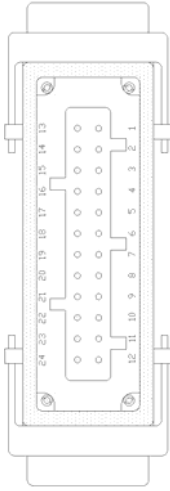
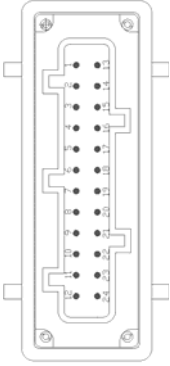
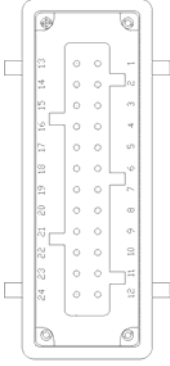
Husky Standard Harting 6z Interflex Cable					
Cable Description: IFLX CBL 6Z J XX.XM* (H24M-2L/H24F-2L) *Available in 4.5 meter length					
Connector on Controller (Han E 24P Female 2 Latch)	Cable – Controller End (Han E 24P Male 2 Latch)	Cable – Mold End (Han E 24P Female 2 Latch)	Zone #	Pin-Out	
			1	1	2
			2	3	4
			3	5	6
			4	7	8
			5	9	10
			6	11	12
			1	13 (+)	14 (-)
			2	15 (+)	16 (-)
			3	17 (+)	18 (-)
			4	19 (+)	20 (-)
			5	21 (+)	22 (-)
			6	23 (+)	24 (-)

Standard Cable Packages

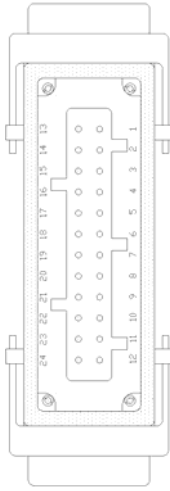
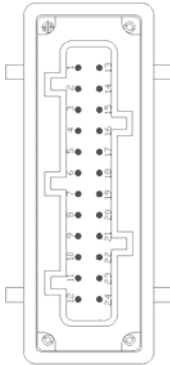
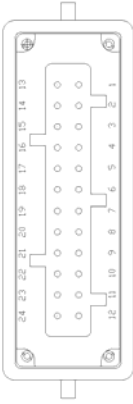
Husky Standard Harting 6z Interflex Cable (Alternating PWR/TC Sequence)					
Cable Description: IFLX CBL 6Z J XX.XM* (H24M-2L/H24F-1L) *Available in 4.5 meter length					
Connector on Controller (Han E 24P Female 2 Latch)	Cable – Controller End (Han E 24P Male 2 Latch)	Cable – Mold End (Han E 24P Female 2 Latch)	Zone #	Pin-Out	
			1	1	2
			1	3 (+)	4 (+)
			2	5	6
			2	7 (+)	8 (+)
			3	9	10
			3	11 (+)	12 (-)
			4	13	14
			4	15 (+)	16 (-)
			5	17	18
			5	19 (+)	20 (-)
			6	21	22
			6	23 (+)	24 (-)

Standard Cable Packages

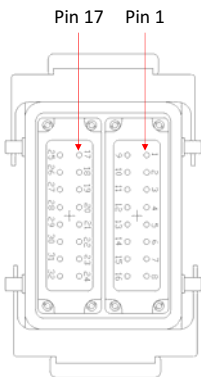
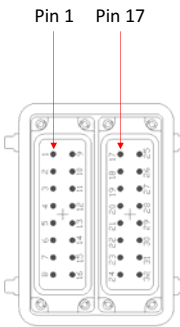
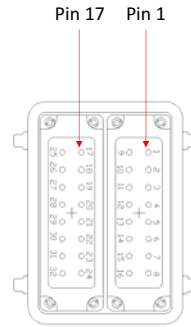
Husky Standard Harting 16z Power Cable (Skinny Inserts)					
Cable Description: PWR CBL 16Z XX.XM* (H32M-2L/H32F-2L) <i>*Available in 4.5, 6, 7.5 and 9 meter lengths</i>					
Connector on Controller (Han A 32P Female 2 Latch)	Cable – Controller End (Han A 32P Male 2 Latch)	Cable – Mold End (Han A 32P Female 2 Latch)	Zone #	Pin-Out	
 <p>Pin 17 Pin 1</p>	 <p>Pin 1 Pin 17</p>	 <p>Pin 17 Pin 1</p>	1	1	9
			2	2	10
			3	3	11
			4	4	12
			5	5	13
			6	6	14
			7	7	15
			8	8	16
			9	17	25
			10	18	26
			11	19	27
			12	20	28
			13	21	29
			14	22	30
			15	23	31
			16	24	32

Standard Cable Packages

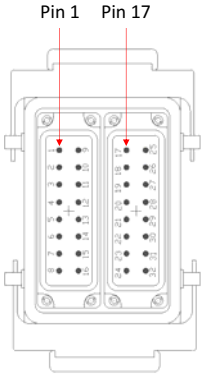
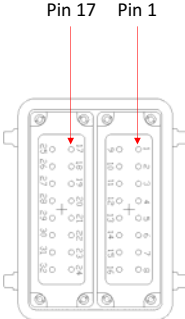
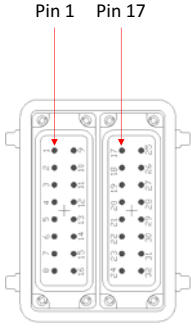
Husky Standard Harting 16z Thermocouple Cable (Skinny Inserts)					
Cable Description: TC CBL 16Z J XX.XM* (H32F-2L/H32M-2L) *Available in 4.5, 6, 7.5 and 9 meter lengths					
Connector on Controller (Han A 32P Male 2 Latch)	Cable – Controller End (Han A 32P Female 2 Latch)	Cable – Mold End (Han A 32P Male 2 Latch)	Zone #	Pin-Out	
				(+)	(-)
			1	1	9
			2	2	10
			3	3	11
			4	4	12
			5	5	13
			6	6	14
			7	7	15
			8	8	16
			9	17	25
			10	18	26
			11	19	27
			12	20	28
			13	21	29
			14	22	30
			15	23	31
			16	24	32

Standard Cable Packages

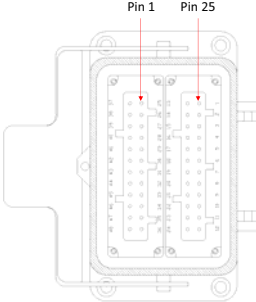
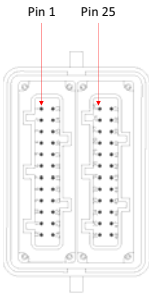
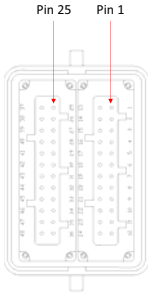
Husky Standard Harting 24z Power Cable				
Cable Description: PWR CBL 24Z XX.XM* (H48M-1L/H48F-1L) *Available in 4.5, 6, 7.5 and 9 meter lengths				
Connector on Controller (Han E 48P Female 1 Latch)	Cable – Controller End (Han E 48P Male 1 Latch)	Cable – Mold End (Han E 48P Female 1 Latch)	Zone #	Pin-Out
			1	1 13
			2	2 14
			3	3 15
			4	4 16
			5	5 17
			6	6 18
			7	7 19
			8	8 20
			9	9 21
			10	10 22
			11	11 23
			12	12 24
			13	25 37
			14	26 38
			15	27 39
			16	28 40
			17	29 41
			18	30 42
			19	31 43
			20	32 44
			21	33 45
			22	34 46
			23	35 47
			24	36 48

Standard Cable Packages

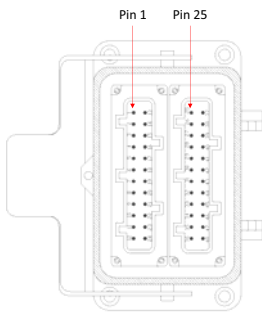
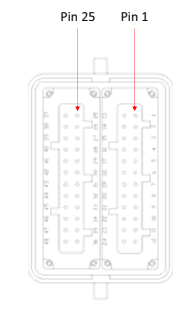
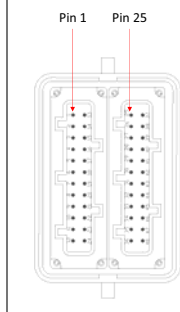
Husky Standard Harting 24z Thermocouple Cable					
Cable Description: TC CBL 24Z J XX.XM* (H48F-1L/H48M-1L) *Available in 4.5, 6, 7.5 and 9 meter lengths					
Connector on Controller (Han E 48P Male 1 Latch)	Cable – Controller End (Han E 48P Female 1 Latch)	Cable – Mold End (Han E 48P Male 1 Latch)	Zone #	Pin-Out	
				(+)	(-)
			1	1	13
			2	2	14
			3	3	15
			4	4	16
			5	5	17
			6	6	18
			7	7	19
			8	8	20
			9	9	21
			10	10	22
			11	11	23
			12	12	24
			13	25	37
			14	26	38
			15	27	39
			16	28	40
			17	29	41
			18	30	42
			19	31	43
			20	32	44
			21	33	45
			22	34	46
			23	35	47
			24	36	48

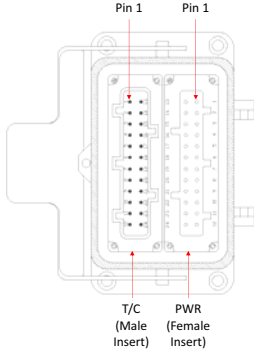
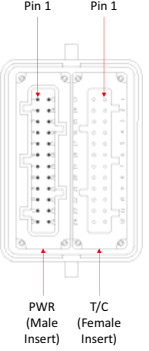
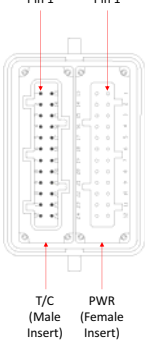

Standard Cable Packages

Husky Standard Harting 12z Interflex Cable					
Cable Description: IFLEX CBL 12Z J XX.XM* (H48MF-1L/H48MF-1L) *Available in 4.5 meter length					
Connector on Controller (Han E 48P M/F 1 Latch)	Cable – Controller End (Han E 48P M/F 1 Latch)	Cable – Mold End (Han E 48P M/F 1 Latch)	Zone #	Pin-Out	
 <p>Pin 1 Pin 1</p> <p>T/C (Male Insert) PWR (Female Insert)</p>	 <p>Pin 1 Pin 1</p> <p>PWR (Male Insert) T/C (Female Insert)</p>	 <p>Pin 1 Pin 1</p> <p>T/C (Male Insert) PWR (Female Insert)</p>	1	1	13
			2	2	14
			3	3	15
			4	4	16
			5	5	17
			6	6	18
			7	7	19
			8	8	20
			9	9	21
			10	10	22
			12	12	24
				1	1(+)
	2	2(+)	14(-)		
	3	3(+)	15(-)		
	4	4(+)	16(-)		
	5	5(+)	17(-)		
	6	6(+)	18(-)		
	7	7(+)	19(-)		
	8	8(+)	20(-)		
	9	9(+)	21(-)		
	10	10(+)	22(-)		
	11	11(+)	23(-)		
	12	12(+)	24(-)		

Standard Cable Packages

Husky Standard Harting 12z Interflex Cable (Mold-Masters Standard)				
Cable Description: IFLEX CBL 12Z J XX.XM* (H48MF-1L/H48MF-1L) *Available in 4.5 meter length				
Connector on Controller (Han E 48P M/F 1 Latch)	Cable – Controller End (Han E 48P M/F 1 Latch)	Cable – Mold End (Han E 48P M/F 1 Latch)	Zone #	Pin-Out
<p>T/C (Male Insert) PWR (Female Insert)</p> <p>Pin 1 Pin 1</p>	<p>PWR (Male Insert) T/C (Female Insert)</p> <p>Pin 1 Pin 1</p>	<p>T/C (Male Insert) PWR (Female Insert)</p> <p>Pin 1 Pin 1</p>	1	1 13
			2	2 14
			3	3 15
			4	4 16
			5	5 17
			6	6 18
			7	7 19
			8	8 20
			9	9 21
			10	10 22
			11	11 23
			12	12 24
			1	1 (+) 13 (-)
			2	2 (+) 14 (-)
			3	3 (+) 15 (-)
			4	4 (+) 16 (-)
			5	5 (+) 17 (-)
			6	6 (+) 18 (-)
			7	7 (+) 19 (-)
			8	8 (+) 20 (-)
			9	9 (+) 21 (-)
			10	10 (+) 22 (-)
			11	11 (+) 23 (-)
			12	12 (+) 24 (-)

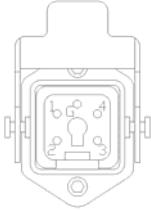
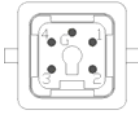
Standard Cable Packages

Husky Standard Harting 1z Interflex Cable (DME One Zone Standard)					
Cable Description: IFLEX CBL 1Z J XX.XM* (H5M-1L/H5F-1L) *Available in 4.5 meter length					
Connector on Controller (Han A 5P Female 1 Latch)	Cable – Controller End (Han A 5P Male 1 Latch)	Cable – Mold End (Han A 5P Female 1 Latch)	Zone #	Pin-Out	
			1	1	4
			1	2 (+)	3 (+)

Non-Standard Cable Package Definitions

Other Industry Standard Cables

Other cable configurations that include connectors of a common rectangular design, manufactured by either Lapp or Harting, are offered at the same price as the standard packages, but include longer lead-times. The following are images of the connectors that would be included with these types of configurations:

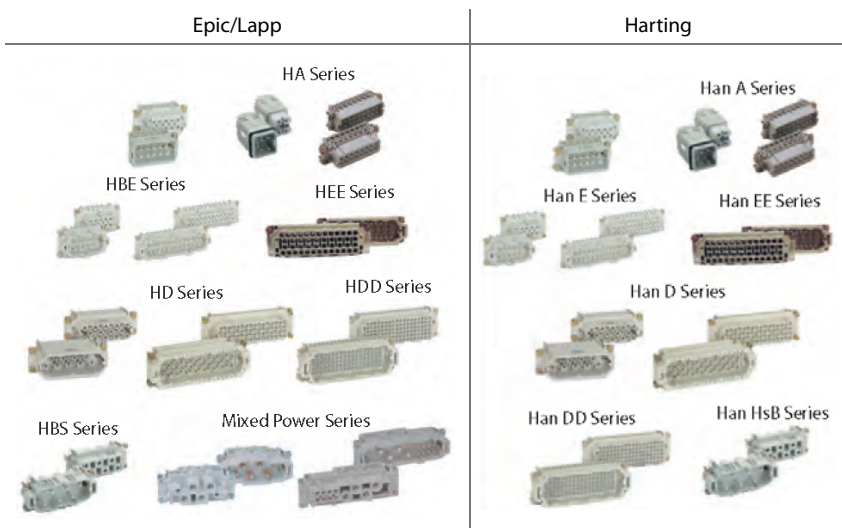

Custom Cables

All cables that are not of a common rectangular design manufactured by either Lapp or Harting are to be quoted as a custom package and are sold at a premium with longer lead-times. The following are images of the connectors that would be included with these types of configurations:



In this section:

Page

16-1	Industry Trending Towards Electrification
16-3	Altanium Servo Control Differentiation
16-4	Altanium Servo Control System Architecture
16-5	Altanium Servo Control Screen Overview
16-9	Motors and Actuators
16-15	Altanium Servo Control Application Assessment
16-16	Signal Interface

Industry Trending Towards Electrification

- Electrification refers to the application of servo motors for controlling hot runner or mold functions
- Functions include but not limited to:
 - Valve Stems
 - Core Pulls
 - Coining Plates
 - Stripper Plates
 - Ejector Plates
 - Unscrewing cores



Ejector, Coining or
Stripper Plates



UltraSync E
Synchronous VG
Control



Core Pulls

Why Electric over Hydraulic or Pneumatic?

Servo control solutions in general:

- Provide greater precision and control of movement, which reduces mechanical stress and increase mold life
- Are naturally cleaner and environmentally friendly with no risk of part contamination or need to dispose of hazardous hydraulic fluid
- Give instant feedback if something goes out of spec so operators can react before damage to the mold occurs, or part quality is compromised
- Are more energy-efficient because the conversion of electrical power to fluid power make hydraulic systems inefficient resulting in greater energy savings
- Require very little maintenance because there are no oil hoses or seals to leak and repair

Altanium servo control solution:

- Offers all the benefits of servo control solutions and more:
 - Altanium servo control includes full engineering support for sizing the servo motor to the application and defining the signal interface to the injection molding machine
 - Altanium servo control includes global startup support and training for faster mold qualifications and smoother integration into production
 - Altanium servo controllers are compatible with a variety of motor types, making it easy to repurpose for different molds

Hydraulic Control System

- Complex w/many components and connections
- Imprecise control
- Hydraulic fluid full of contaminants
- Inefficient energy usage

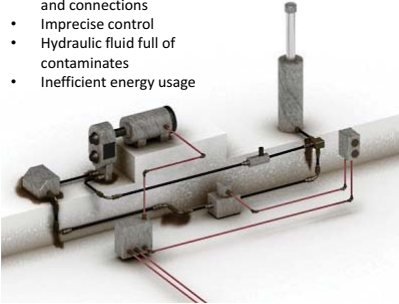



















Servo Control System



- Simple w/few components and connections
- Precise control
- Clean electrical power
- Highly energy efficient



Altanium Servo Control Differentiation

- Comparison versus custom one-off solutions and i-mold (EMEA competitor)
 - Ease and Speed of Integration
 - Initial installation and commissioning can be done in half the time of a conventional system
 - Actuators and drives commissioned at the factory
 - On-site start-up support and training
 - Easily repeatable for like-applications
 - Ease of Use and Performance
 - Modifications to motion profile and system settings are significantly easier to execute
 - Scan rate from the time the command is received and executed is considerably faster (2ms per axis vs. ~17ms)
 - Ease of Doing Business (Customer Intimacy)
 - Full service application engineering support during order process
 - Turn-key motion control solution: controller + actuators
 - Scalable Integrated Solution
 - Standard all-in-one operator interface
 - 6 axes of servo control plus temperature, UltraSync-E and ISVG control
 - Motion profile settings transferable between systems
 - Customizable I/O interface w/IMM and mold
 - Controller Re-Purposing
 - Standard solution allows for re-purposing for use on other molds/applications
 - Drive units cover a wide range of motor sizes
 - Global Support Network
 - Spare parts and technical service

Value Driver	Husky	Custom	I-Mold (EMEA)
Ease of Speed and Integration			
Ease of Use and Performance			
Ease of Doing Business			
Scalable Integrated Solution			
Controller Re-Purposing			
Global Support Network			

Best -  Average -  Poor - 

Altanium Servo Control System Architecture

Matrix5

Altanium Servo Control is a Matrix5 based control technology that consolidates all system functions into a single operator interface



Servo Drives

Used to amplify the command signal from the control system and transmit electric current to the servo motor to produce motion

Linear Axes

Any servo motor that moves a mechanical mechanism in a linear motion

Rotary Axes

Any servo motor that moves a mechanical mechanism in a rotary motion

Machine Interface

Connectors and cabling used to route the I/O and safety signals between the machine and controller

Mainframe Configurations

Available as standalone systems (Servo control only)

OR

Integrated with hot runner control (Max 4 Stacks including servo section)

(Size of servo section is determined by the quantity & size of the drives)

1, 2 or 3 Stack Enclosure Based on Quantity and Size of Drives

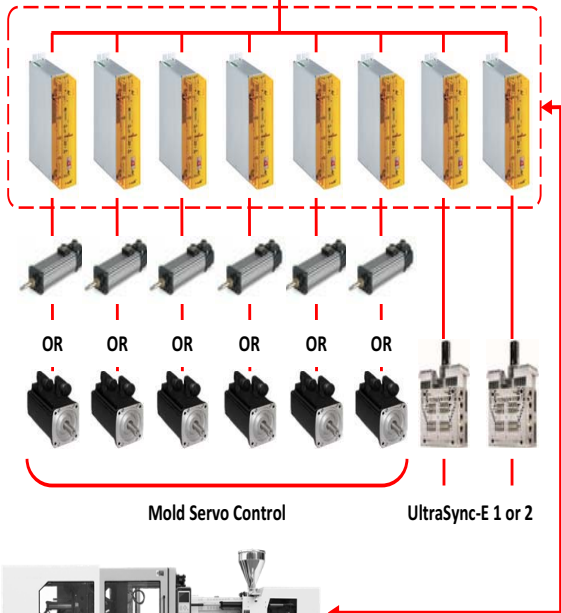

Mold Servo Control

UltraSync-E 1 or 2

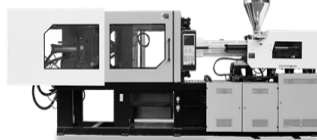

- Indexing and Safety Signals
- Connectors and pin-out can be Husky Standard or Customer Defined

1 Stack: 1-2 Drives



1-2 Axes:

- H = 1244mm (49")
- W = 457mm (18")
- D = 558mm (22")

2 Stack: 2-6 Drives



2-6 Axes:

- H = 1244mm (49")
- W = 508mm (20")
- D = 558mm (22")

3 Stack: 7-8 Drives



5-8 Axes:

- H = 1270mm (50")
- W = 762mm (30")
- D = 558mm (22")



1-2 Axes:

- H = 1244mm (49")
- W = 508mm (20")
- D = 558mm (22")



2-6 Axes:

- H = 1270mm (50")
- W = 762mm (30")
- D = 558mm (22")



5-8 Axes:

- H = 1270mm (50")
- W = 965mm (38")
- D = 558mm (22")

Altanium Servo Control Screen Overview

- Key features supported by the Altanium Servo Controller:
 - User configurable digital I/O for indexing and interlock signals from IMM
 - Two speed jogging mode
 - Ability to add a custom name to individual axis and I/O signals
 - Grouping for easy parameter changes and manual operations
 - Position and force warning and alarm settings
 - User definable permissions for initiating calibration, enabling override mode, indexing to a position and at a position
 - Multi-step motion profile for each indexed move
 - Time and force curves displayed for each axis

Servo Home Screen



- Overview of all Axes
- Access to other Servo screens
- Status, Force and Positions per Axis
- Display all/actual Axis positions
- Manual Operations
 - Home Position
 - Index Move
 - Stop
 - Calibrate
- Manual Jogging

Controller Setup Screen

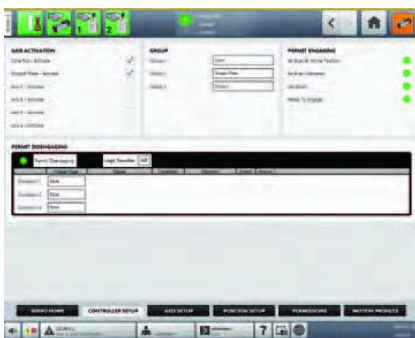

- Enter Group name
- Group Definition for Activation
- Individual Axis enabling
- Status Overview of all Axes:
 - All Calibration OK
 - All Home
 - No Faults
 - Ready to Engage (Auto Mode)

Altanium Servo Control Screen Overview

Axis Setup Screen



- Axis Type Selection (Linear/Rotary)
- Calculated Max Values per Axis
- Force / Speed / Accel / Decel Limits
- Define Positive Motion (Extend/Retract/CW/CCW)
- Manual Jogging Speed Definition
- Idle and Relax Settings
- Index Speed Scaling (%) for Manual and Automatic Mode
 - Controller Engaged, IMM in Auto
 - Controller Engaged, IMM in Manual
 - Controller Disengaged
 - Homing

Axis Position Setup Screen



- Max/Min Stroke
- Number of Positions
- Name of Positions
- Target Value per Position
 - Calibration Settings
 - Calibration Reference
 - Calibration Force and Speed
 - Go-To Position after Calibration
- Tolerance Window for At Position
- Alarm Window for Position Deviation
- Force Warning % (Trend info)

Altanium Servo Control Screen Overview

Axis Permissions Screen



- 8 Permission settings per Axis
- Position/Signal selection
- Status LED
- Signal Inversion (NO/NC)
- Permission as Start or Continuous Condition
- Jogging using Index Position (Otherwise jog in override mode only)
- Sequencing of Axis/Steps
 - Start Trigger (Signal) per Indexed Move
 - Apply Hold Force
 - Set Relax Limit

Motion Profile Screen



- Target Positions per Axis and Step
- Define Number of Motion Steps
- Motion Profiles
 - Position (Forward/Back)
 - Speed
 - Accel / Decel
 - Force Limit per Step
- Motion Curves
 - Speed/Force per Indexed Motion Step
 - Curve Values Displayed by Touching Curve
- Measured Values every Cycle
 - Position
 - Move time
 - Peak force
- Stored for viewing in Process History screen

Altanium Servo Control Screen Overview

Servo I/O Screen



- Access to all Safety and Digital I/O channels
- Provides status of all connected signals
- Fields for adding user definable labels to each I/O channel
- Each I/O channel can be inverted or set to be forced high or low
- All I/O channels are labeled with the call out in the electrical schematic for easy identification
- Configurable signals are outputs that use Boolean logic and can be assigned inputs, outputs and other signals as conditions for a specified adjustable signal that when all are TRUE the specified signal is ON



Motors and Actuators

General Information:

- The number of axes (Axis = 1 Motor), type of motion, force, torque, speed and lifetime requirements will determine the quantity, type and size of the motor or actuator
- If customers want Husky to supply the servo motors or actuators we will quote solutions from our preferred suppliers
- Customers can supply their own servo motors or actuators, but they must be compatible with our control system
- Retrofit applications with existing motors will be evaluated for compatibility based on the supported feedback type
- All motors and actuators, including those supplied by the customer, must be tuned at the factory with the controller before shipping to the customer or mold maker

Common Servo Configurations:

- Altanium Servo Controllers are compatible with all common servo configuration used in the injection molding industry:

Servo Motor

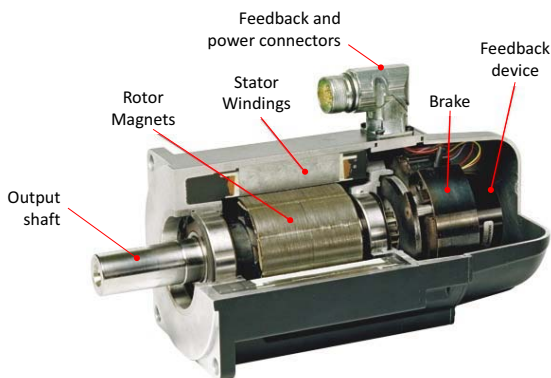

Pro: Relatively inexpensive, shorter lead-times

Con: Requires external mechanism to translate rotary motion to liner motion

Motors and Actuators

Linear Actuator with Integrated Servo Motor

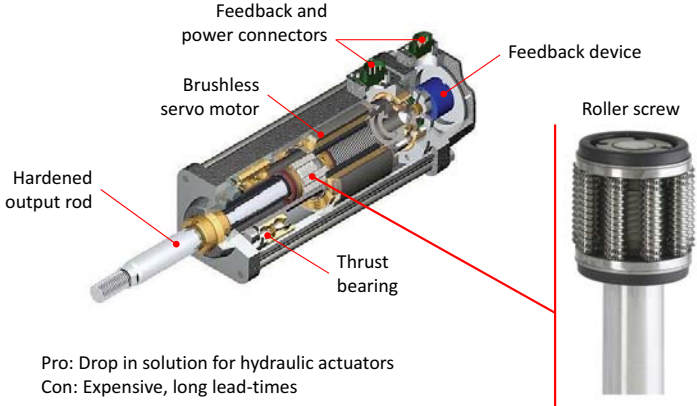

Linear Actuator with Bolt-on Servo Motor

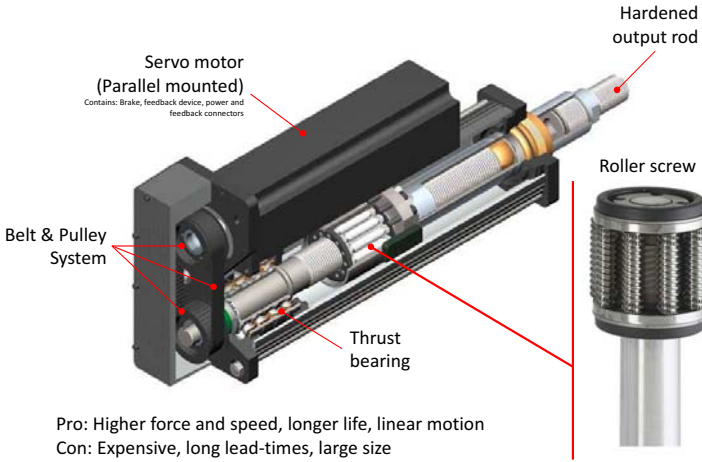

Motors and Actuators

Gearboxes:

- Also known as a gearhead, a gearbox is a mechanical unit consisting of a series of integrated gears within a housing that is used in rotary motion power transmission applications to alter torque and speed between the servo motor and the load
- The need for a gearbox is determined during the application analysis and is typically used to multiply the torque of the motor based on a gear ratio

Gearbox Layout

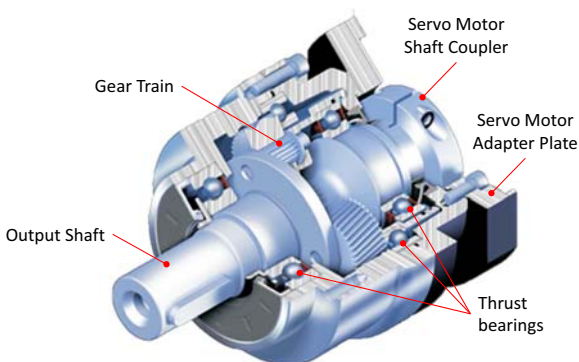

Gearbox and Servo Motor Assembly

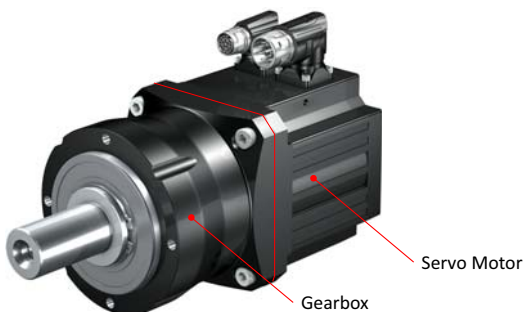

Gearbox Configurations



Inline Gearbox
w/Output Shaft



Inline Gearbox
w/Flange Output Shaft



Right-Angle Gearbox
w/ Output Shaft



Motors and Actuators

Compatible Feedback Types:

- Closed loop feedback is what differentiates a servo system and is used to sense the speed, direction and position of the motor shaft
- Altanium Servo Controllers support three types of motor feedback devices:
 - Resolver
 - Analog feedback of absolute position within one revolution
 - More robust solution for demanding environments
 - Requires recalibration after power loss
 - Absolute Encoder (EnDat® 2.1 and Hiperface®)
 - Digital feedback of absolute position
 - Most precise and accurate feedback device
 - If power is lost, its output will be correct whenever power is restored, so it is not necessary to recalibrate (Reference position)
 - Incremental Encoder (Sin/Cos and TTL)
 - Electromechanical feedback that does not indicate absolute position
 - Generates a series of pulses that are stored on an external buffer for calculating position
 - Inexpensive when compared to absolute encoders, but not as robust as resolvers
 - Requires recalibration after power loss

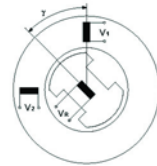

Motors and Actuators

Husky Preferred Motors and Actuator Suppliers

- Baumuller

- Servo Motors
 - Supplier of UltraSync-E motors
 - Speeds up to 6000rpm
 - Compact design with high power density
 - Excellent smooth running characteristics
 - High overload capability
 - Resolver feedback (other options available)



- Exlar

- Linear Actuators
 - All-in-one compact unit w/ integrated motor
 - High capacity roller screw exceeds ball screw load ratings and life
 - EnDat® 2.1 absolute encoder (other options available)
 - Very popular in industry for linear applications

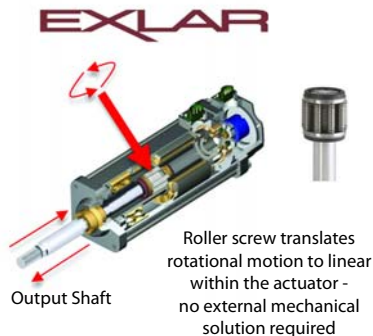

Motors and Actuators

Other Compatible Servo Motor and Actuator Brands:

- Altanium Servo Controllers are compatible with several servo motor brands outside of our preferred suppliers
- Compatibility of these motors is determined by the feedback type
- The table below includes a list of servo motor suppliers that are compatible with ASC (*Consult the factory for suppliers not on this list*)

Servo Motor Supplier		Compatible*	Used w/ASC**
Baumüller		✓ Preferred Supplier	✓ Preferred Supplier
Exlar		✓ Preferred Supplier	✓ Preferred Supplier
Tolomatic		✓	✓
Stober		✓	✓
Diakont		✓	✓
Infranor		✓	✓
Bosch-Rexroth		✓	✓
HDD		✓	✓
Kollmorgen		✓	✓
Lenze		✓	✓
Baldor		✓	
B&R		✓	
Control Techniques		✓	
Sigmatek		✓	
Heidrive		✓	

*Compatible = It has been confirmed that this supplier has motors that are available with feedback types compatible with ASC

**Used w/ASC = We have used motors from this supplier with ASC on applications running in the field

Note: Most manufactures offer a range of supported feedback types, including the ability to retrofit an existing motor or actuator so it is compatible with ASC

Altanium Servo Control Application Assessment

Application Scenarios and Minimal Required Information to Quote

- New mold design with servo motors and Altanium Servo Control
 - Information Required:
 - Refer to Minimal Required Information for Budgetary Quote table below
 - Solid model of the mold design (If available)
- Existing mold with hydraulic cylinders to be retrofitted with servo actuators and Altanium Servo Control
 - Information Required:
 - Refer to Minimal Required Information for Budgetary Quote table below
 - Manufacture and full model string of hydraulic cylinder
 - Solid model of the mold design (If available)
- New mold design with customer supplied servo motors and Altanium Servo Control
 - Information Required:
 - Refer to Minimal Required Information for Budgetary Quote table below
 - Manufacture and full model string of servo motors or actuators
 - Solid model of the mold design (If available)
- Existing mold with servo motors and controller, but only replacing the controller with Altanium Servo Control
 - Information Required:
 - Refer to Minimal Required Information for Budgetary Quote table below
 - Manufacture and full model string of servo motors or actuators
 - Solid model of the mold design (If available)

Minimal Required Information for Budgetary Quote

Number of Axes	1-6		
Running Voltage	200-240v	380-415v	460-500v
Motion Type	Rotary		Linear
Axis Function	Pull, Eject, Rotate, Unscrew, Stip, etc.		
Axis Mounting Direction	Vertical		Horizontal
Weight (Mass) that Servo is Moving	lb		Kg
Peak Force per Axis	lbf	N	lb-ft Nm
Working Stroke (Approximately)	inch		mm
Estimated Cycle Time	Sec		
Time for Servo Movement	Sec		

Signal Interface

General Information

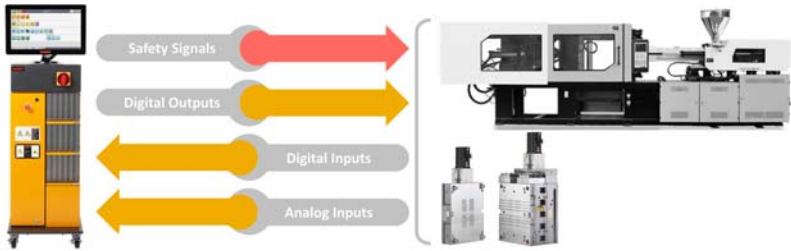

- The signal interface is a set of connectors that contain the safety, indexing, and permission signals that connect the Altanium Servo Controller to the injection molding machine and mold



- This interface is a critical part of the controller design and is defined during the application review process

General Information

- The quantity of supported signals is based on the size of the Altanium Servo Control enclosure

Servo Enclosure Soze	Husky Standard	Cables	Safety Signals	Digital Inputs	Digital Outputs	Analog Inputs
Single Stack (Standalone and Integrated)						
	X200* EM131N*	6m/20ft**	E-Stop Safety Gates (2 Channel)	10 (User Definable)	7 (User Definable)	0***
Double/Triple Stack (Standalone and Integrated)						
	X200* X201* EM131N	6m/20ft**	E-Stop Safety ates (2 Channel)	26 (User Definable)	15 (User Definable)	8*** (0-10V) (User Definable)
* Custom interfaces are available upon request. Upcharges may apply based on type and quantity of connectors used						
** Standard cables are included in controller price. Upcharges apply to longer lengths, special connectors and quantities exceeding the standard						
*** Analog input are a paid option and are available in two or three stack servo enclosure only						

In this section:

Page

17-1 Altanium Valve Gate Sequencer (VGS)

Altanium Valve Gate Sequencer (VGS)

Altanium VGS is:

- A complete Pneumatic and Hydraulic sequential control solution for up to 32 individual valve gates
- Highly configurable and operates based on position, time or any combination of other user definable analog and digital inputs
- Ideal for multi-gated parts used in the automotive and consumer electronics market

Valve Gate Sequencing allows for:

- Controlling when pneumatic or hydraulic valve gates open and close during each injection cycle
- Precision control over weld line positioning during part filling
- Ensuring the aesthetics and structural integrity of colored and glass filled parts
- Reductions in clamp tonnage requirements or elimination of weld lines by using a progressive fill technique called cascade molding
- Mechanical balancing of family molds

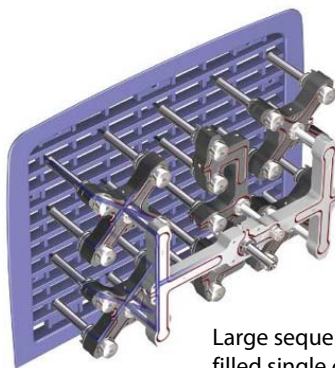

Large sequentially filled single cavity Automotive part

Altanium Valve Gate Sequencer (VGS)

Features

Feature	Altanium VGS	Advantage
Available with integrated hot runner control	✓	Save cost and time by controlling two critical aspects of the process (VG and Temp) using a common operator interface
VGS overview (Home) screen	✓	Saves time by providing an overview of the entire sequence, from a single screen, to ensure everything is working correctly or for trouble shooting problems in the process
Highly configurable signal interface to support multiple methods of triggering a sequence (Time, Digital or Analog)	✓	Provides the flexibility to connect the controller to any number of available outputs signals, eliminating the need to pay for expensive upgrades on the machine
Compatible with analog signal from linear position transducer that can be easily configured to trigger the VG sequence based off IMM screw position	✓	As a volumetric measurement of the available plastic in the mold, triggering the sequence off screw position is the most accurate and repeatable way to control valve gates, resulting in higher quality parts and less scrap
Manually actuate valve gates from the controller	✓	Manually controlling valve gates is a simple and effective way to confirm how the solenoids are configured and that the system is connected properly
At-Temperature function with soak timer	✓	Protects gates and valve stems from damage by preventing any actuation until the mold has reach processing temperature and has soak the appropriate amount of time to allow stems to move freely
Packing function	✓	Allows individual valve gates to open and close up to 3 times in a single cycle which is critical to some processes for optimized quality by allowing targeted areas of the part to be packed further during injection
Dedicated safety gate input	✓	Forces all stems to the closed position, when safety gates are opened, to protect personnel from resin burns

Altanium Valve Gate Sequencer (VGS)

Available Configurations

Operator Interfaces



Delta5:

- 4-16 Circuits
- Standard I/O



Matrix5:

- 4-32 Circuits
- Expanded I/O

Integrated (VGS + HRC Control)



Standalone (VGS Control Only)

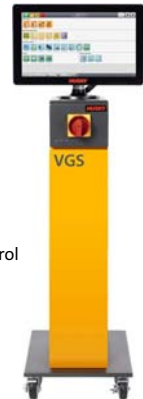

Altanium Valve Gate Sequencer (VGS)

Hardware Layout (Low Circuit Configurations):

- Low circuit VGS control configurations are sold in 4 circuit increments starting at 4 circuits up to a maximum of 16 circuits:
 - 4 Circuits = 1 Bay
 - 8-16 Circuits = 2 Bays
- Available with Delta5 or Matrix5 operator interfaces

VGS Drawer Assemblies

8-16 Circuits (Second Drawer):
Power Supply and Circuit Protection

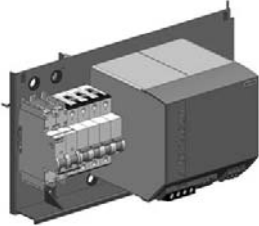

8-16 Circuits (First Drawer):
I/O Slices and Com. Buss

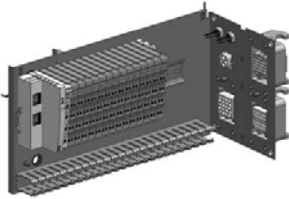

4 Circuits (First Drawer):
Power Supply, Circuit Protection,
I/O Slices, and Com. Buss

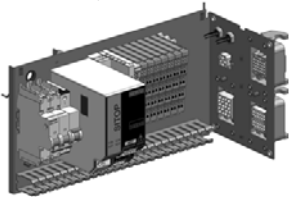

Mainframe

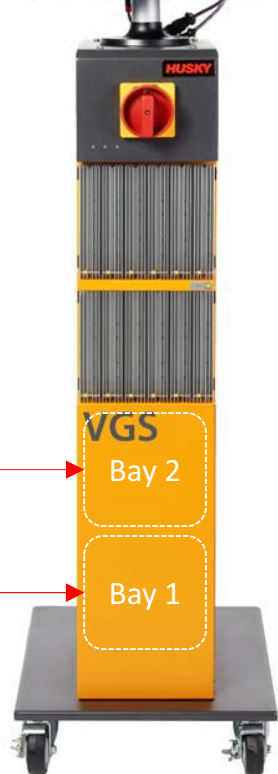

Note: There is an upcharge for configurations that require an additional mainframe stack to be added to accommodate the VGS components when sold with integrated hot runner control

Altanium Valve Gate Sequencer (VGS)

Hardware Layout (High Circuit Configurations):

- High circuit VGS control configurations are sold in 4 circuit increments from 20 circuits up to a maximum of 32 circuits:
 - 20-24 Circuits = 3 Bays
 - 28-32 Circuits = 4 Bays
- Available with Matrix5 operator interface only

VGS Drawer Assemblies

Mainframe

28-32 Circuits (Fourth Drawer):
Power Supply and Circuit Protection

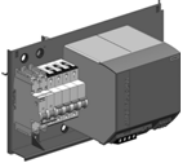

20-32 Circuits (Third Drawer):
I/O Slices and Com. Buss

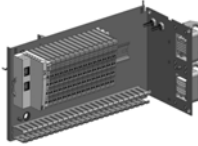

20-24 Circuits (Second Drawer):
Power Supply and Circuit Protection

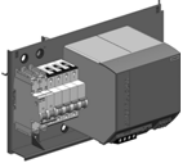

20-32 Circuits (First Drawer):
I/O Slices and Com. Buss

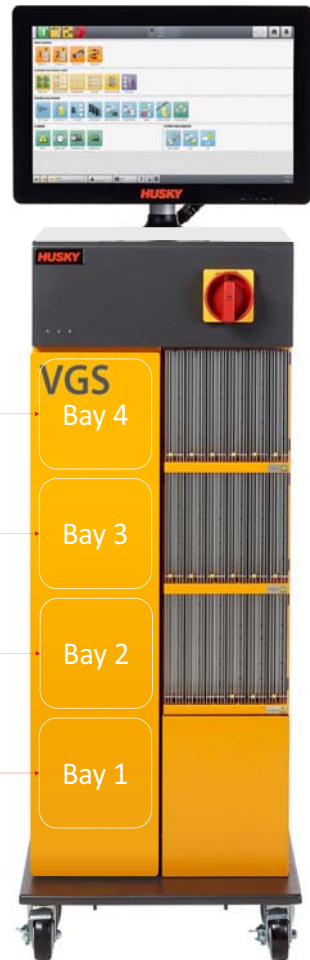
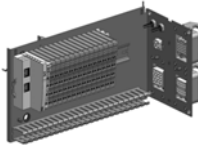

Altanium Valve Gate Sequencer (VGS)

Available Signals:

Signal Type	Qty	Purpose	Comments
Digital Inputs	8 or 36	User configurable for triggers that interface with the IMM or auxiliary equipment	<p>Two digital inputs are used for the following signals:</p> <ul style="list-style-type: none"> • IMM Safety Gate Status • VGS Enable <p>These are safety inputs and cannot be changed</p> <ul style="list-style-type: none"> • 8 digital Inputs are standard on all configurations • 28 additional digital inputs are standard on 20-32 circuit configuration or a paid option on 4-16 circuit configurations
Digital Outputs	4	User configurable for signals to the IMM	
24VDC Outputs	4-32	Control for solenoids on air valves or hydraulic valves	2 amps per circuit
0-10V Analog Inputs	4	User configurable for position feedback or other analog sensors in the mold or IMM	One analog 0-10 V input dedicated to an optional linear position transducer
4-20mA Analog Inputs	2	User configurable for analog sensors in the mold or IMM	

Associated Connectors on Rear of Controller:

Base Connectors for 4-32 Circuits

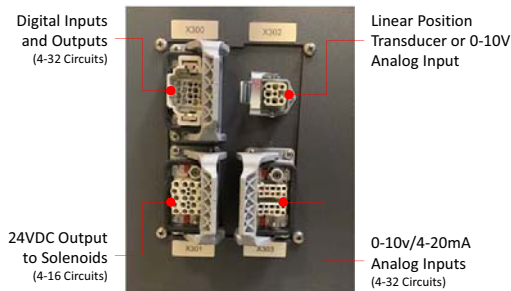

Additional Connectors for 20-32 Circuits or Expanded I/O Option

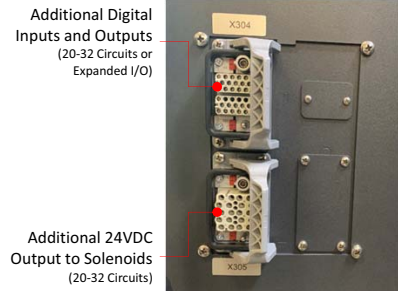

Altanium Valve Gate Sequencer (VGS)



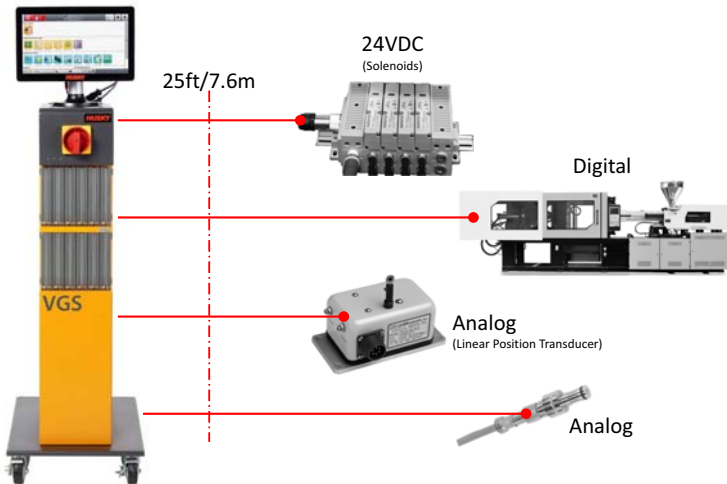

Available Cables:

Cable Type	Length Ft/M	Purpose	Comments
Digital I/O w/ Flying Leads	25/7.6	Connecting digital inputs & outputs to IMM	Standard – Included w/ all controller configurations
Solenoid Output 2-16 CIR w/Flying Leads	25/7.6	Connecting 24VDC signals to other air valves	Standard – Included w/ controller when configured for 4-16 circuits
Solenoid Output 17-32 CIR w/ Flying Leads	25/7.6	Connecting 24VDC signals to other air valves	Standard – Included w/ controller when configured for 20-32 circuits
Solenoid Output 2-8 CIR w/ Connector	25/7.6	Connecting 24VDC signals to Husky air kits	Optional – Included w/1-16 circuit Husky circuit air kit
Solenoid Output 17-32 CIR w/ Connector	25/7.6	Connecting 24VDC signals to Husky air kits	Optional – Included w/17-32 circuit Husky circuit air kit
Position Transducer w/ Connector	25/7.6	Connecting to Husky linear position transducer	Optional – Included w/Husky linear position transducer
Position Transducer Flying Leads	25/7.6	Connecting to other linear position transducers or a 0-10V analog device	Optional
Analog Inputs Flying Leads	25/7.6	Connecting to 0-10V or 4-20mA analog devices	Optional



Altanium Valve Gate Sequencer (VGS)

Available Options

Option	Description	Comments
<p>Linear Position Transducer (LPT) Kits</p> 	<p>102mm/10" Linear Pull String Transducer</p> <p>Note: Longer lengths available upon request (Up to 2,032mm/80")</p>	<p>Includes cable w/ compatible linear position transducer connector</p>
<p>Low Circuit Air Kits</p> 	<p>1-16 Numatics Solenoid Air Valves, Regulator, Shutoff Valve, and associated hoses and fittings</p>	<p>Includes cable w/ compatible valve stack control connector</p>
<p>High Circuit Air Kits</p> 	<p>17-32 Numatics Solenoid Air Valves, Regulator, Shutoff Valve, and associated hoses and fittings</p>	<p>Includes cables w/ compatible valve stack control connectors</p>
<p>Hydraulic Power Units (HPU)</p> 	<p>Standalone 8 or 16 Circuit Hydraulic Power Unit for hydraulic actuated valve gate applications</p>	<p>Includes cable w/ compatible valve stack control connector</p>

RECYCLABLE



Husky actively protects its technical and design innovations through a global intellectual property strategy. Husky currently has more than 900 patents and patent applications worldwide. The equipment shown in this publication may be covered by one or more of these patents.

*/© 2020 Husky Injection Molding Systems 2020